

## NITROGEN IN WEST AFRICA: THE REGIONAL CYCLE<sup>1</sup>

G. PHILIP ROBERTSON<sup>2</sup> AND THOMAS ROSSWALL<sup>3</sup>

*SCOPE/UNEP<sup>4</sup> International Nitrogen Unit, Royal Swedish Academy of Sciences,  
S-104 05 Stockholm, Sweden*

**Abstract.** We have calculated a nitrogen cycle budget for West Africa south of the northern Sahara that quantifies biologically important pools of nitrogen in the region and major fluxes associated with these pools. Major compartments of our model include noncultivated systems broken down by vegetation zone, successional status, and plant components; annual and perennial crops each broken down by crop species and plant and harvest components; wetlands; anthropic systems; and soils and sediments. Base reference year is 1978.

Biological nitrogen fixation and precipitation fluxes dominated nitrogen inputs to West Africa in 1978. Approximately  $12 \times 10^9$  kg were fixed in noncultivated systems; about half of this was fixed in early successional (0–6 yr) rain forests, and much of the rest in grazed or fallow savanna grasslands and woodlands. Less than  $0.7 \times 10^9$  kg were fixed in cultivated systems; legumes accounted for  $\approx 25\%$  of this. Total anthropic sources (fossil fuel combustion, fertilizer production, and agricultural commodity imports) were minor ( $< 0.3 \times 10^9$  kg). Precipitation inputs to the region were  $\approx 0.4 \times 10^9$  kg.

Most nitrogen leaving West Africa did so volatilized by fire ( $\approx 8.3 \times 10^9$  kg), principally in non-cropped systems. Major losses also occurred via hydrologic export to the Atlantic Ocean ( $1.5 \times 10^9$  kg) and via denitrification ( $1.1 \times 10^9$  kg). Total N losses from West Africa exceeded  $11.0 \times 10^9$  kg. The nitrogen immobilized in growing woody vegetation appeared to have amounted to  $\approx 5.6 \times 10^9$  kg. Most was immobilized in forested regions by vegetation regrowth during the fallow phase of the bush fallow crop rotation cycle, the dominant cropping system in West Africa. A very small amount was immobilized by perennial crops such as cacao and rubber. Net immobilization in soil was not estimated; total soil N was assumed to be in steady state for the region as a whole.

Our overall budget balances within 1%, despite independent calculations of all major fluxes. The balance portrays a nitrogen cycle dominated by pools and fluxes in noncropped systems. In contrast to N balances in developed regions, direct anthropic fluxes are a minor part of the West Africa cycle. Indirect human influences, however, mainly through effects on vegetation cover, appear to be a major determinant of both the rates at which nitrogen is cycled in West Africa and the relative importance of most pools and fluxes.

*Key words:* global biogeochemistry; nitrogen; nitrogen models; tropical nutrient cycling; West Africa.

### INTRODUCTION

Increased recognition of the importance of the major biogeochemical cycles to global climate and primary productivity has drawn attention recently to the value of large-scale element models for assessing the effects of human activity on these cycles. Global models of the carbon, nitrogen, sulfur, and phosphorus cycles (e.g., Söderlund and Svensson 1976, Bolin et al. 1979, Rosswall 1981, Bolin et al. 1983) have led to useful insights into global-level problems such as increasing concentrations of atmospheric CO<sub>2</sub>, N<sub>2</sub>O-mediated ozone degradation in the stratosphere, and acid precipitation.

Most research on complete biogeochemical cycles has thus far focused on particular sites in specific biome

types (e.g., Likens et al. 1977, Rosswall and Granhall 1980, Sollins et al. 1980, Batey 1982), and data from these studies form the basis for extrapolations to global levels. The conceptual jump between individual watershed studies and global syntheses is a large one, however, and the development of budgets at intermediate, regional levels could improve substantially the resolution of future global models (NAS 1978). Regional level cycles also are valuable for assessing what is known about element cycle processes in particular ecosystems of a region (Robertson 1982), and for addressing region-specific environmental policy questions (NAS 1978, Keeney 1979, Hauck and Tanji 1982).

Regional budgets for nitrogen have been compiled for parts of the United States (Lipman and Corybear 1936, Ayers and Branson 1973, Miller and Smith 1976, NAS 1978, Keeney 1979, Messer and Brezonik 1983), for the undisturbed forests of Amazonia (Salati et al. 1982), and for the open ocean (Fogg 1982) and Baltic Sea (Rönnner 1985), but at present there are no such syntheses for developing regions of the tropics or subtropics. We believe that this lack is unfortunate because these regions constitute an important part of the terrestrial biosphere and should not be underrepresented

<sup>1</sup> Manuscript received 15 August 1983; revised 25 January 1985; accepted 16 April 1985.

<sup>2</sup> Present address: W. K. Kellogg Biological Station, Michigan State University, Hickory Corners, Michigan 49060-9516 USA.

<sup>3</sup> Present address: Department of Water in Environment and Society, University of Linköping, S-581 83 Linköping, Sweden.

<sup>4</sup> SCOPE is the Scientific Committee on Problems of the Environment of the International Council of Scientific Unions (ICSU); UNEP is the United Nations Environment Program.

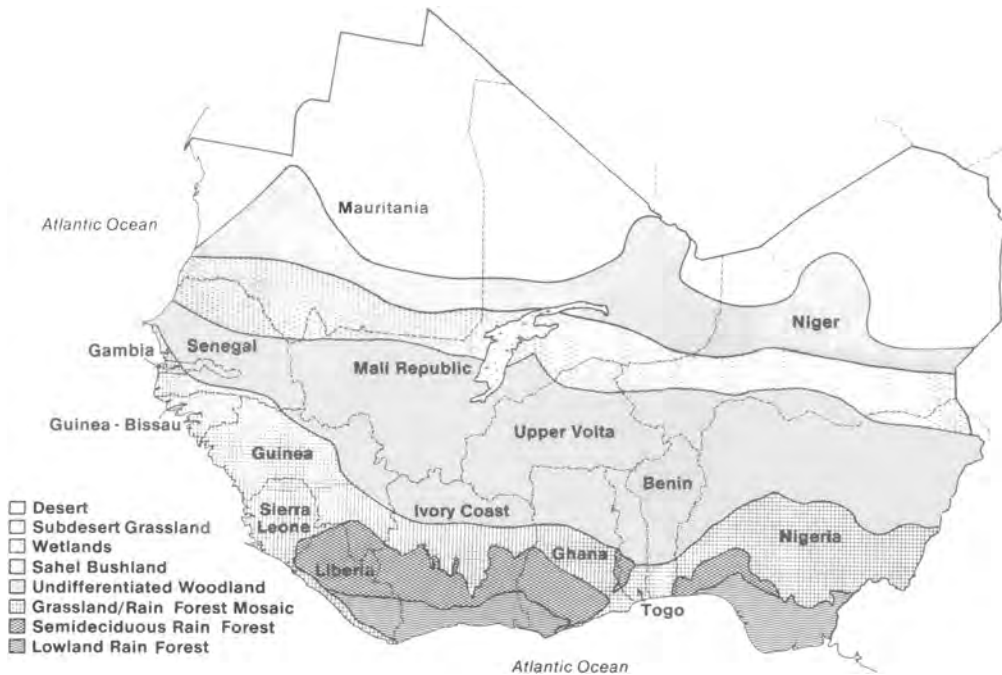

FIG. 1. Geographic boundaries and major vegetation zones in West Africa (from White 1983). Precipitation isohets follow roughly the vegetation zones.

in future global syntheses. Moreover, well-managed nitrogen resources are central to stemming the trend of stagnating per capita agricultural productivity present in many developing regions of the tropics (CEQ 1980, Greenwood 1982). Since nitrogen fertilizers are not generally available in these areas, conserving existing nitrogen resources and enhancing natural sources of nitrogen are closely related to improving crop and livestock production. Rapidly changing patterns of land use in these regions also dictate an urgent need for tropical budgets: land-use transformations imply concomitant changes in nitrogen and other nutrient fluxes, and some of these changes may have global consequences through effects on climate and atmospheric chemistry.

In this paper we present a detailed model of the nitrogen cycle for West Africa south of the northern Sahara (Fig. 1). For a number of reasons this region is a logical choice for a first tropical synthesis. First, as a region, West Africa suffers markedly from declining agricultural productivity relative to population growth (Fig. 2). The decline has been especially severe in those parts of the region affected by the 1970–1980 Sahelian drought (Franke and Chasin 1980), and recent evidence showing that Sahelian grassland productivity may be as restricted by nitrogen and phosphorus as by precipitation (Penning de Vries et al. 1980a, Breman and de Wit 1983) illustrates the importance of nitrogen resources even in arid portions of the region.

Second, West Africa is geographically discrete, with abrupt biogeochemical boundaries on all sides but the

east. To the north is the Sahara Desert and to the west and south, the Atlantic Ocean. Arbitrary political boundaries that include the eastern shore of Lake Chad and that approximate watershed boundaries define the easternmost edge of the region (Fig. 1).

Third, precipitation patterns result in a number of well-defined vegetation zones similar to regions in many other tropical areas. Vegetation types range from desert vegetation in the north to lowland rain forest in the south, and thus the larger area can be straightforwardly divided into biogeochemical subunits that may be directly compared with such zones in other regions.

Fourth and finally, there is a relatively strong research base on which to construct a regional nitrogen budget (see, for example, Rosswall 1980). That this base is actively growing suggests that a regional synthesis may be useful for summarizing existing system-level work and for focusing attention on neglected but potentially important processes.

#### CLIMATIC, VEGETATION, AND LAND USE PATTERNS IN WEST AFRICA

West Africa as defined in this model comprises 15 adjoining states covering  $606 \times 10^6$  ha (Fig. 1). It is bounded by the Sahara Desert and by the Atlantic Ocean, and on the east by the eastern borders of Niger and Nigeria. With minor exceptions, topographic relief throughout the region is gentle or flat, ranging from sea level to 500 m elevation, with occasional highland projections to  $>900$  m. Major watersheds include  $206 \times 10^6$  ha drained by the 4200-km Niger River, and wa-

tersheds of the 1430-km Senegal River and the 1600-km Volta River in Ghana.

Jones and Wild (1975) and Okigbo (1980) provide detailed overviews of the region's geology and climate. Crystalline igneous and metamorphic rocks of the Precambrian Basement Complex underlay the southern landscape, with the northern underlain by unconsolidated or poorly consolidated sands and undifferentiated Basement Complex. Extensive sedimentary areas occur in the northwest Terminal Continental region, and scattered pockets of volcanic origin occur in the highlands and near Dakar, Senegal. Active dune fields extended as far south as the present 1000-mm isohyet at various times during the Pleistocene.

West African precipitation isopleths describe latitudinal bands increasing southward from <25 to >3000 mm/yr. Climates correspondingly range from arid in the north to perhumid and humid along the southern coast. The annual north-south migration of the Inter-tropical Zone of Convergence, in which north-flowing oceanic air meets the dry Harmattan wind from the Sahara, results in rainy seasons of <2.5 mo near the Sahara to 10–12 mo in coastal regions. Major vegetation zones correspond broadly to these precipitation patterns; White (1983) recently identified >24 major phytogeographic associations within the region, synthesized in Fig. 1.

Intense and increasing population pressures in the south and drought-exacerbated overgrazing in the north have left little of the natural vegetation undisturbed in recent years. Less than 2% of the lowland rain forest is currently estimated to be >40 yr old (Vitousek et al. 1980), and increasingly shorter fallow periods in the traditional and widespread rotational bush fallow cultivation cycle are reducing the proportion of forest in mid successional (7–40 yr) growth stages (Fig. 3). Rapid rates of mature forest disappearance (Myers 1980) show little sign of abating, so that older (mature and mid-successional) forests will likely represent far less than the present 13% of total forested area in West Africa by the end of the century.

Deforestation in the savanna and Sahel regions is also rapidly altering previous equilibria; rising population pressures brought about by increased life expectancies and mechanically dug wells have stimulated overgrazing, increased the proportion of land under cultivation, and significantly elevated the demand for firewood, the predominant cooking fuel in both rural and urban areas (Fishwick 1970). In addition, recent dry years with little herbaceous ground cover have resulted in repeated defoliation of woodland trees by pastoralists' herds for fodder. This defoliation may have permanent consequences (Wickens and White 1979).

West African cultivation systems range from traditional forms of shifting cultivation to intensive monocultures (Fig. 4), although variants of the former still predominate (Okigbo 1980). Large farms are rare; >80% of the farms in both southern and northwestern

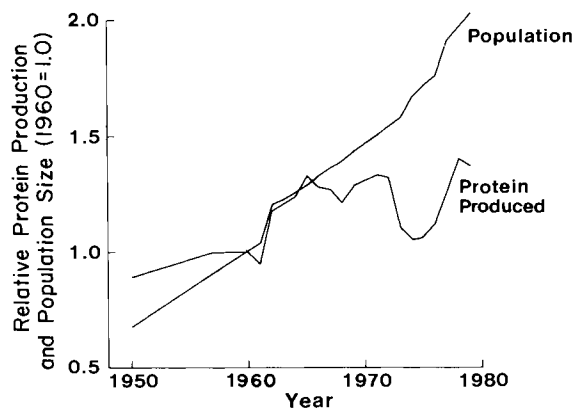

FIG. 2. Human population size and estimated crop protein production in West Africa, 1950–1979, relative to 1960 levels. Population size in 1960 was  $67.2 \times 10^6$  individuals; estimated protein production was  $3.53 \times 10^9$  kg, based on 1960 crop production estimates of  $11.4 \times 10^9$  kg cereals (3.2% N fresh mass),  $2.87 \times 10^9$  kg grain legumes (4.0% N fresh mass), and  $25.0 \times 10^9$  kg roots and tubers (0.33% N fresh mass). Livestock production is not included. Annual production estimates calculated from FAO (1971, 1975, 1980a).

Nigeria, e.g., are <2 ha in area (Okigbo 1980), and cacao (*Theobroma cacao*), oil palm (*Elaeis guineensis*), and other perennial crops amenable to large plantation systems are grown principally on small holdings (Wills 1962, Hance 1975). Farm size is at least partly a function of the absence of draft animals; endemic trypanosomiasis in the south and the lack of year-round fodder in the north restrict most permanent farms to small livestock such as goats, sheep, and poultry.

In the subdesert, Sahel, and much of the savanna regions nomadic pastoralism and transhumance is common. Herds of cattle, sheep, and goats are driven south annually with the rainfall, and although the 1970–1980 drought has forced many of the pastoralists onto farms or into cities (Franke and Chasin 1980), extensive grazing remains the predominant land use for the Sahel and savanna zones of West Africa (Penning de Vries et al. 1980b).

#### THE WEST AFRICAN NITROGEN CYCLE

We have attempted below to compile a regional nitrogen budget for West Africa. The values reported refer to West Africa of the late 1970's, and where possible and appropriate, particularly for agricultural fluxes, to 1978. We recognize that the region is not in steady state. Land use patterns and agricultural management practices change year by year, and climatic fluctuations result in annual variations that will be reflected in biological activity and thus in nitrogen fluxes in both managed and noncropped portions of the region. Comparisons of nitrogen pools and fluxes reported here with those for other regions should therefore be made with care; our goal is to provide a context for such comparisons mainly within the region.

Central to all large-scale biogeochemical models is

**Vegetation Zones****Land Use Status**

FIG. 3. Vegetation zones and land use within zones in 1978 West Africa. Superscript numbers refer to the following notes: 1. Value includes  $39.5 \times 10^6$  ha of lowland rainforest and  $41.6 \times 10^6$  ha of moist semideciduous forest; lowland rainforest (LRF) includes White's (1983) wet type LRF plus 50% of his wet-dry mosaic, 25% of his LRF-successional grassland mosaic, and 17% of his LRF-*Isobertinia* woodland-successional grassland mosaic. Moist semideciduous forest (MSDF) includes White's (1983) drier type LRF and the same percentages of the LRF mosaics. 2. Value includes  $36 \times 10^6$  ha of derived savanna grassland and  $184 \times 10^6$  ha of Guinea savanna woodland. Derived savanna includes 50% of White's (1983) lowland rainforest (LRF)-successional grassland mosaic, 33% of the LRF-*Isobertinia* woodland-successional grassland mosaic, and all of the  $<1 \times 10^6$  ha coastal mosaic. Guinea savanna includes White's (1983) Sudanian woodland with *Isobertinia* and undifferentiated, and 33% of the LRF-*Isobertinia* woodland-successional grassland mosaic. 3.  $40 \times 10^6$  ha, includes White's (1983) Sahel acacia wooded grassland and deciduous bushland. 4.  $72.6 \times 10^6$  ha. 5.  $180 \times 10^6$  ha includes White's (1983) absolute desert, coastal desert, desert dunes with and without perennial vegetation, and regs, hamadas, and wadis. 6.  $5.5 \times 10^6$  ha, includes White's (1983) halophytic and mangrove swamp vegetation. 7.  $8.2 \times 10^6$  ha; from UNESCO (1978), FAO (1980a), and White (1983). 8. 90% of the zone is assumed to be part of a cultivation cycle, with 23% in a crop phase and 77% in an early successional bush-fallow phase (Nye and Greenland 1960, Braun 1973, Greenland 1980); of the 20% in forest, 18% is assumed to be in mid successional vegetation (7-40 yr) and 2% in mature (>40 yr) forest (Vitousek et al. 1980). 9. Assumes 35% of the area is cultivated (Penning de Vries et al. 1980b, Singh and Balasubramanian 1980a) with 50% of this in an early successional fallow phase (Nye and Greenland 1960, Braun 1973, Singh and Balasubramanian 1980a). 10. Assumes 10% of the area is cultivated (Penning de Vries et al. 1980b) with 50% of this in fallow (see note 8).

an early decision regarding the scale at which to aggregate model compartments. We have chosen a level of aggregation for the present model that we believe provides insight into interactions among most major nitrogen pools and processes in the region. For many compartments this level was predetermined by the limited availability of data; further resolution will thus in many cases depend on future research.

*Regional nitrogen inputs*

Nitrogen enters West Africa primarily via atmospheric deposition, biological nitrogen fixation, and imported agricultural commodities. From  $<1$  to  $28$  kg/ha has been estimated to enter various West African systems in bulk precipitation each year (Table 1). Rates of deposition vary monotonically with rates of annual precipitation, suggesting that most of the nitrogen arrives dissolved in rainwater rather than in dry particulate forms.

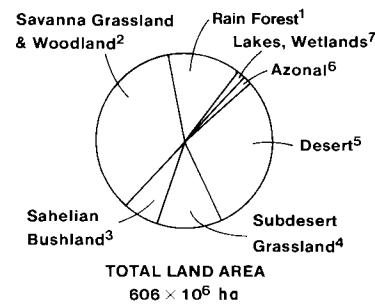
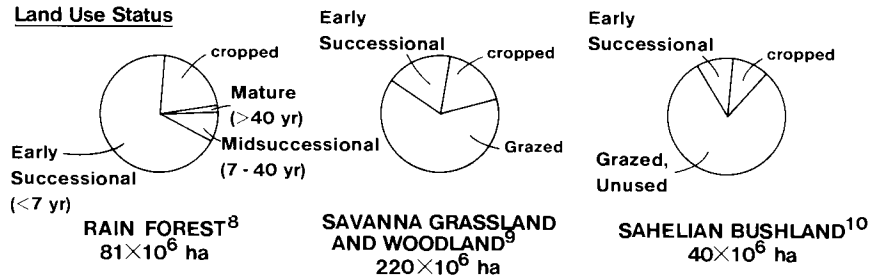
No direct measures of nitrogen in dry fallout are available, although in at least one case (Jones 1972), nitrogen in sample containers open only during rainfall events did not differ much from previous open-container measurements. Although Harmattan winds that sweep south from the Sahara during the dry season transport substantial amounts of Saharan dust to sub-Saharan and coastal areas, this dust appears to contain little nitrogen. McTainsh (1980), for example, measured dust deposition rates in northern Nigeria in excess of  $1700 \text{ kg} \cdot \text{ha}^{-1} \cdot \text{yr}^{-1}$  for 1978-1979; of this, 990 kg appeared to be from nonlocal sources. However, because aeolian Saharan soils typically contain  $<0.01\%$  N and  $<0.05\%$  P (FAO-UNESCO 1977), nitrogen inputs from Harmattan dust are likely to be  $<0.1 \text{ kg} \cdot \text{ha}^{-1} \cdot \text{yr}^{-1}$ .

Most nitrogen enters West Africa by way of biological nitrogen fixation in noncropped ecosystems (Table

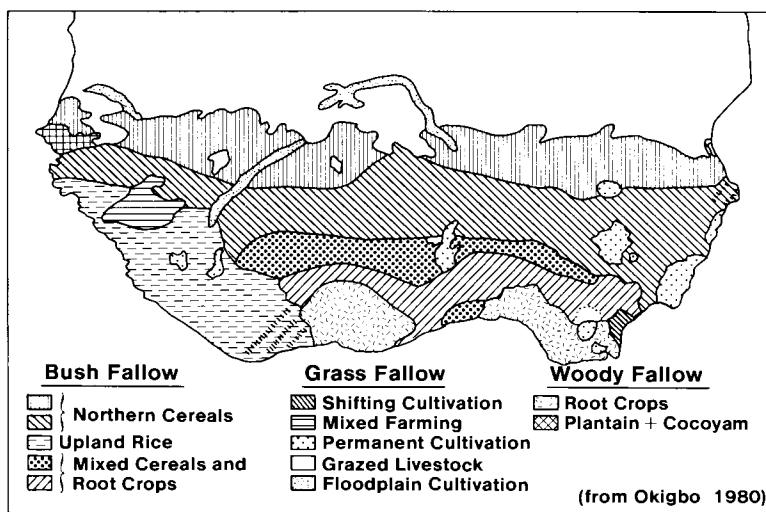

FIG. 4. Major crop zones in West Africa.

2). Fixation rates within these systems vary substantially both by vegetation zone and, within zones, by land use and the successional status of the vegetation. Nitrogen fixed in early rain forest successions amounted to  $\approx 100 \text{ kg} \cdot \text{ha}^{-1} \cdot \text{yr}^{-1}$  (Table 2), but this probably tapers to  $\approx 15 \text{ kg} \cdot \text{ha}^{-1} \cdot \text{yr}^{-1}$  in mature rain forests. In noncultivated savannas, nitrogen fixation rates appear to be on the order of  $30 \text{ kg} \cdot \text{ha}^{-1} \cdot \text{yr}^{-1}$ , with rates for Sahelian noncultivated areas near half of this.

The source of the nitrogen fixed in rain forests is not known with certainty, although the importance of non-symbiotic sources is implied by the relative absence of nodulated legumes in many rain forest successions (Beirnaert 1941, Keay 1953, Bonnier 1957, Nye and Greenland 1960, Norris 1969). In savanna regions, symbiotic, algal, and other nonsymbiotic sources appear to be equally responsible for the nitrogen fixed in noncultivated sites, and lower Sahelian rates appear to be largely due to the relative absence of both nodulated legumes (Bernhard-Reversat and Poupon 1980, Penning de Vries et al. 1980b) and nonsymbiotic nitrogen fixers (Penning de Vries et al. 1980b). Blue-green algal crusts appear to represent an important source of fixed nitrogen in savanna and particularly in Sahel regions; Reynaud and Roger (1981) reported nitrogen fixation rates by rain-stimulated algal mats that approached  $60 \text{ kg/ha}$  over the course of a recent rainy season in a low-lying area typical of 10% of the Senegalese Sahel.

We are not aware of estimates for nitrogen fixation in West African lakes. Horne and Viner (1971) estimated nitrogen inputs of  $\approx 44 \text{ kg} \cdot \text{ha}^{-1} \cdot \text{yr}^{-1}$  for Lake George, Uganda, and West African rates are probably similar. Nitrogen fixation in temperate lakes ranges to  $\approx 60 \text{ kg} \cdot \text{ha}^{-1} \cdot \text{yr}^{-1}$  (Lean et al. 1978).

Approximately 17% of the total biologically fixed nitrogen in West Africa was fixed in cultivated systems. Legumes account for  $\approx 30\%$  of the  $788 \times 10^6 \text{ kg}$  fixed

in cultivated systems in 1978 (Table 3). In unfertilized, low-nutrient soils typical of much of West Africa, grain legumes such as cowpeas (*Vigna unguiculata*) and groundnuts (*Arachis hypogaea*) acquire most of their nitrogen from the atmosphere. Substantial rates of nitrogen fixation may also occur under sugarcane and rice crops (Table 2), although on a regional basis fixation under nonleguminous upland crops in cultivated forest and savanna systems is substantially more important.

TABLE 1. Annual deposition inputs of nitrogen (dry + wet) to West Africa. na = not available.

Annual precipitation (mm)	Deposition-N $\text{kg} \cdot \text{ha}^{-1} \cdot \text{yr}^{-1}$		Regional total N <sup>9</sup> $10^6 \text{ kg/yr}$
	Mineral N	Total N	
>1800	6 <sup>1</sup>	25 <sup>2</sup>	985
1200-1800	8 <sup>3</sup>	12 <sup>4</sup>	499
800-1200	5 <sup>5</sup>	7 <sup>6</sup>	1540
300-800	na	3 <sup>7</sup>	116
0-300	na	3 <sup>8</sup>	759
Total			3899

<sup>1</sup> Roose (1974).<sup>2</sup> Nye and Greenland (1960):  $15 \text{ kg} \cdot \text{ha}^{-1} \cdot \text{yr}^{-1}$ ; Bernhard-Reversat (1975b): 23-25; Roose (1974): 21; Roose (1978): 28.<sup>3</sup> Meyer and Pamper (1959):  $5.4 \text{ kg} \cdot \text{ha}^{-1} \cdot \text{yr}^{-1}$ ; Nye (1961): 14.<sup>4</sup> Vitousek et al. (1980):  $10-15 \text{ kg} \cdot \text{ha}^{-1} \cdot \text{yr}^{-1}$ .<sup>5</sup> Jones and Bromfield (1970):  $4.5 \text{ kg} \cdot \text{ha}^{-1} \cdot \text{yr}^{-1}$ ; Jones (1971, 1972): 4.6 for wet only.<sup>6</sup> Thornton (1965):  $40-42 \text{ kg} \cdot \text{ha}^{-1} \cdot \text{yr}^{-1}$ ; Penning de Vries et al. (1980b): 5; Roose (1978): 5.4.<sup>7</sup> Thornton (1965):  $13 \text{ kg} \cdot \text{ha}^{-1} \cdot \text{yr}^{-1}$ ; Bernhard-Reversat (1982): 0.4; Penning de Vries et al. (1980b): 3; Bernhard-Reversat and Poupon (1980): 4; Bille (1977): 2.3.<sup>8</sup> P. Reynaud (personal communication).<sup>9</sup> Based on areal extents in Fig. 1; >1800 mm rainfall = lowland rain forest, 1200-1800 mm = semideciduous rain forest, 800-1200 mm = savanna grassland and woodland, 300-800 mm = Sahel bushland, 0-300 mm = subdesert grassland and desert.

TABLE 2. Nitrogen fixed in West African vegetation zones, except N fixed by leguminous crops (see Table 3) and from anthropic sources (see Table 5). na = not available.

System*	Local N fixation (kg·ha <sup>-1</sup> ·yr <sup>-1</sup> )			Total	Regional total (10 <sup>6</sup> kg/yr)
	Symbiotic	Algal	Other†		
Forests					
Cultivated	na	na	6 <sup>2</sup>	6	102
Early successional	na	na	na	100 <sup>3</sup>	5590
Mid-successional	na	na	na	60 <sup>4</sup>	390
Mature	na	na	na	15 <sup>5</sup>	24
Savanna					
Cultivated	na	1 <sup>6</sup>	6 <sup>2</sup>	7 <sup>1</sup>	276
Grazed, fallow	10 <sup>8</sup>	10 <sup>10</sup>	10 <sup>9</sup>	30	5400
Sahel					
Cultivated	na	1 <sup>6</sup>	6 <sup>2</sup>	7 <sup>1</sup>	27
Grazed, fallow	2 <sup>7</sup>	10 <sup>11</sup>	0 <sup>7</sup>	12	415
Subdesert					
Grazed, unused	0	<1 <sup>12</sup>	0	<1	36
Wetlands					
Lakes	0	44 <sup>13</sup>	0	44	361
Lowland rice <sup>23</sup>	0	18 <sup>14</sup>	53 <sup>16</sup>	71 <sup>15</sup>	56
Dryland crops					
Sugarcane <sup>24</sup>	3 <sup>17</sup>	6 <sup>19</sup>	40 <sup>18</sup>	49	3
Upland rice <sup>23</sup>	0	5 <sup>22</sup>	6 <sup>19</sup>	11	17
Coffee and cacao <sup>25</sup>	0 <sup>20</sup>	0	<1 <sup>21</sup>	<1	<1
Total					12 698

\* Areal extents of systems are from Fig. 3 unless noted otherwise.

† Other = nonsymbiotic, nonalgal sources included in Total.

<sup>1</sup> Does not include N<sub>2</sub> fixation by leguminous crops.

<sup>2</sup> Moore (1966) in Greenland (1977): 30 kg·ha<sup>-1</sup>·yr<sup>-1</sup>; Tjepkema and van Berkum (1977): 1; Singh and Balasubramanian (1980a): 10; Steyn and Delwiche (1970) in Burns and Hardy (1975): 4; Barber et al. (1976) in Knowles (1978): 0.9; Balandreau (1975) in Knowles (1978): 8; Odu and Vine (1968): 4.

<sup>3</sup> Bartholomew et al. (1953): 114 kg·ha<sup>-1</sup>·yr<sup>-1</sup>; Nye and Greenland (1960): 106; Jaiyebo (1961) in Moore (1966): 181; Dommergues (1963): >100.

<sup>4</sup> Bartholomew et al. (1953): 39 kg·ha<sup>-1</sup>·yr<sup>-1</sup>; Vitousek et al. (1980): 50–150 (lowland rain forest) and 20–80 (moist semideciduous forest).

<sup>5</sup> Greenland and Nye (1959): 56–169 kg/ha over lifetime; Vitousek et al. (1980): 10–20 kg·ha<sup>-1</sup>·yr<sup>-1</sup>; F. Bernhard-Reversat (*personal communication*): 15 kg·ha<sup>-1</sup>·yr<sup>-1</sup>.

<sup>6</sup> Penning de Vries et al. (1980b): 0–1 kg·ha<sup>-1</sup>·yr<sup>-1</sup>; P. Reynaud (*personal communication*): 1 (dry land) to 60 (irrigated) kg·ha<sup>-1</sup>·yr<sup>-1</sup>.

<sup>7</sup> Penning de Vries et al. (1980b): 2 kg·ha<sup>-1</sup>·yr<sup>-1</sup> by rhizobia, 0 by Other.

<sup>8</sup> Kass and Drosdoff (1970) in Sanchez (1976): 0 kg·ha<sup>-1</sup>·yr<sup>-1</sup> (tall-grass) and 0–10 (short-grass); Penning de Vries et al. (1980b): 10; Singh and Balasubramanian (1980a): 20.

<sup>9</sup> Odu and Vine (1968): 40 kg·ha<sup>-1</sup>·yr<sup>-1</sup>; Odu (1977): 20–50; Kass and Drosdoff (1970) in Sanchez (1976): 0–23 (tall-grass) and 0–12 (short-grass); Penning de Vries et al. (1980b): 5.

<sup>10</sup> Kass and Drosdoff (1970) in Sanchez (1976): 0–10 kg·ha<sup>-1</sup>·yr<sup>-1</sup> (short-grass and tall-grass); Penning de Vries et al. (1980b): 5; Isichei (1980): 8 (3–9); Stewart et al. (1978): 30. Nonsymbiotic + algal: Balandreau and Villemain (1973): 7.5 kg·ha<sup>-1</sup>·yr<sup>-1</sup>; Greenland (1980): <20; Singh and Balasubramanian (1980a): <5; Singh and Balasubramanian (1980b): <15; Balandreau et al. (1974, 1976): 4–9.

<sup>11</sup> Penning de Vries et al. (1980a): 1 kg·ha<sup>-1</sup>·yr<sup>-1</sup>; Stewart et al. (1978): 3.0; Reynaud and Roger (1981): 57; P. Reynaud (*personal communication*): 0–60.

<sup>12</sup> P. Reynaud (*personal communication*): 0–1 kg·ha<sup>-1</sup>·yr<sup>-1</sup>.

<sup>13</sup> Horne and Viner (1971): 44 kg·ha<sup>-1</sup>·yr<sup>-1</sup> for Lake George, Uganda.

<sup>14</sup> Range 3–40 kg·ha<sup>-1</sup>·yr<sup>-1</sup>, *n* = 12; Yoshida et al. (1973): 3 kg·ha<sup>-1</sup>·yr<sup>-1</sup>; Reynaud and Roger (1978): 3–8; Yoshida and Ancajas (1973): 3–14; Alimagno and Yoshida (1977) in Buresh et al. (1980): 18–33; Watanabe et al. (1978) in Buresh et al. (1980): 19; Traore et al. (1978): 25–40; Watanabe and Lee (1977): 18–33. Data for crops not fertilized as far as known. The estimate is based on 1 crop/yr and includes fixation by *Azolla*.

<sup>15</sup> Koyama and App (1979): 35–50 and 8–38 kg·ha<sup>-1</sup>·yr<sup>-1</sup>; Yoshida and Ancajas (1973): 60–77; Yoshida (1971) in Balandreau et al. (1975): 80. Data for crops not fertilized as far as known. The estimate is based on 1 crop/yr.

<sup>16</sup> Balandreau et al. (1974) in Balandreau et al. (1976): 36 kg·ha<sup>-1</sup>·yr<sup>-1</sup>; Balandreau et al. (1974, 1975): 45; Rinaudo et al. (1971) and Rinaudo and Dommergues (1971): 60–80.

<sup>17</sup> 2–6 kg·ha<sup>-1</sup>·yr<sup>-1</sup>, *n* = 3; Döbereiner et al. (1972): 2; Ruschel et al. (1978b) in Ruschel and Vose (1982): 2–6. Data for fixation within plant.

<sup>18</sup> Döbereiner et al. (1972): 67 kg·ha<sup>-1</sup>·yr<sup>-1</sup>; Ruschel et al. (1978b) in Ruschel and Vose (1982): 50; also Döbereiner et al. (1973) estimates total (including symbiotic) = 50 kg·ha<sup>-1</sup>·yr<sup>-1</sup>.

<sup>19</sup> 5–7 kg·ha<sup>-1</sup>·yr<sup>-1</sup>, *n* = 2; Yoshida and Ancajas (1973).

<sup>20</sup> Leguminous shade trees not present.

<sup>21</sup> 0.4–0.6 kg·ha<sup>-1</sup>·yr<sup>-1</sup>, *n* = 2; Roskoski (1982).

TABLE 3. Nitrogen fixed by leguminous crops. N uptake values are from Table 7.

Crop	Total N uptake (10 <sup>6</sup> kg/yr)	Percent N fixed symbiotically	Total N fixed (10 <sup>6</sup> kg/yr)
Soybeans	7.6	90*	6.8
Cowpeas	85.5	89†	76.1
Groundnuts	80.8	85	68.7
Others	25.9	85	22.0
Total			174

\* Range 40–90%,  $n = 8$ ; based on <sup>15</sup>N (Ruschel et al. 1979), nodulated vs. non-nodulated isolines (Weber 1966, Lynch 1968, Hashimoto 1971, Vest 1971 in Vest et al. 1973, Pal and Saxena 1975) and solution culture (Allos and Bartholomew 1959); estimate assumes unfertilized crops grown on soils of low fertility (E. Kuinen, *personal communication*).

† Eaglesham et al. (1977).

In 1978, the nitrogen content of commercial fertilizer produced in the region was  $14.3 \times 10^6$  kg (FAO 1979f), which was apparently <0.5% of the total nitrogen fixed biologically in West Africa that year. An additional  $73.5 \times 10^6$  kg of fertilizer nitrogen was imported (Table 4), but fertilizers still accounted for only a small amount of the nitrogen added to systems of the region. This contrasts with recent estimates that  $\approx 20\%$  of the total nitrogen fixed in terrestrial systems globally is fixed via commercial fertilizer production (Söderlund and Svensson 1976). Almost three times the amount of fertilizer nitrogen fixed in West Africa was indirectly fixed via fossil-fuel combustion in the region (Table 5). A portion of this NO<sub>x</sub>-N may subsequently enter terrestrial and aquatic systems via precipitation, although in West Africa prevailing winds in the principal industrial zone along the coast may take much of this nitrogen out to sea. Nonetheless, elevated rates of nitrogen deposition may occur near urban areas.

Another  $227 \times 10^6$  kg of nitrogen entered West Africa by way of agricultural trade in 1978 (Table 4). About 32% of this arrived as N-fertilizer, with most of the remainder arriving in marine fish, wheat, and rice.

#### *Agricultural pools and fluxes*

Major crop zones in West Africa include those for root crops, plantains (*Musa* spp.), and maize (*Zea mays*) along the eastern coast, a rice (*Oryza sativa*) zone along the western coast, and a mixed-cereal zone in the north (Harris 1976 in Okigbo 1980; Fig. 4). Cereals, in particular millet (*Pennisetum typhoideum* and *Panicum*

TABLE 4. Nitrogen inputs to West Africa in 1978 via agricultural trade (net agriculture imports). Fertilizer and crop import data are from FAO (1979f and 1979a, respectively), and crop N contents are from Table 8, except as noted. na = not available.

Commodity	Mass (10 <sup>9</sup> kg/yr)	N content (%)	N input (10 <sup>6</sup> kg/yr)
Fertilizer	na	na	73.5
Agricultural products			
Wheat and other cereals			
Wheat and other cereals	2.2*	2.2	47.7
Rice	1.5	1.8	26.8
Maize	0.3	2.6	6.5
Fibre	<0.1	2.0	0.4
Potatoes	<0.1	0.38	0.1
Other vegetables	<0.1	0.15	0.1
Tobacco	<0.1	2.0	0.2
Fish	1.3†	3.0	69.3
Meat	<0.1‡	3.0	2.6
Total			227

\* Includes  $0.14 \times 10^6$  kg malt, and  $0.17 \times 10^6$  kg other cereals.

† FAO (1979c, d); imports plus marine catches; all national exports ( $10.15 \times 10^6$  kg) are assumed to be consumed within region.

‡ Includes  $81.5 \times 10^6$  kg fresh and frozen meat,  $6.6 \times 10^6$  kg live ruminants.

*milliaceum*), sorghum (*Sorghum vulgare*), maize, and rice provide the major source (65–75%) of indigenous protein in the region (FAO 1979a). Grain legumes such as cowpeas, groundnuts (peanuts), and soybeans (*Glycine max*), and roots and tubers such as yams (*Dioscorea* spp.), cassavas (*Manihot esculenta*), and cocoyams (*Colocasia esculenta* and *Xanthosoma*

TABLE 5. Annual nitrogen oxide (mainly NO<sub>2</sub> and NO) emissions from the combustion of fossil fuels.

Source	(Units)	Amount consumed* (10 <sup>9</sup> units)	NO <sub>x</sub> -N emission factor (g/unit)	N emitted (10 <sup>6</sup> kg/yr)
Natural gas	(m <sup>3</sup> )	0.08	2.9†	0.2
Gasoline	(kg)	2.31	5.1†	12.0
Kerosene	(kg)	1.12	5.1	5.7
Fuel oil	(kg)	4.54	5.1	23
Total				41

\* UN (1977) figures for 1975, increased by 15% to correct for 15% population increase between 1975 and 1978 (FAO 1980a).

† EPA (1973) in NAS (1978: 658); assumes most natural gas used for power production and a mean gasoline use efficiency of 3.8 km/L.

<sup>22</sup> P. Reynaud (*personal communication*): 0–10.

<sup>23</sup> Total rice extent =  $2.4 \times 10^6$  ha (FAO 1980a); estimates assume that 33% of rice area is lowland rice, 67% upland rice (NAS 1974).

<sup>24</sup> Areal extent =  $0.06 \times 10^6$  ha (FAO 1980a).

<sup>25</sup> Areal extent =  $3.9 \times 10^6$  ha (FAO 1980a).

TABLE 6. Annual-crop biomass in 1978. Primary (1°) harvest biomass is yield mass reported by FAO (1979a); secondary (2°) harvest is the biomass removed at the same time as at primary harvest but not included in FAO figure (e.g., shells and pods). Total crop biomass = primary harvest + secondary harvest + litter + root residue. na = not available.

Crop	1° harvest biomass <sup>1</sup> (10 <sup>9</sup> kg)	Aerial residue (AR) <sup>2</sup>			Root residue (RR) <sup>2</sup>		
		1° harvest : AR ratio	2° harvest : AR ratio	2° harvest (10 <sup>9</sup> kg)	Litter (10 <sup>9</sup> kg)	1° harvest : RR ratio	Biomass (10 <sup>9</sup> kg)
<b>Cereals</b>							
Millet	6.8	0.26 <sup>3</sup>	0.7 <sup>4</sup>	18	7.8	0.73 <sup>5</sup>	9.3
Sorghum	5.1	0.24 <sup>6</sup>	0.7 <sup>4</sup>	17 <sup>7</sup>	4.5	1.0 <sup>8</sup>	5.3
Maize	3.2	0.67 <sup>9</sup>	0.16 <sup>10</sup>	1.7 <sup>11</sup>	3.1	2.0 <sup>12</sup>	1.6
Lowland rice	2.4 <sup>13</sup>	0.85 <sup>14</sup>	<0.1	<0.1 <sup>15</sup>	2.8	0.33 <sup>16</sup>	7.2
Upland rice	0.9 <sup>13</sup>	1.1 <sup>17</sup>	<0.1	<0.1 <sup>15</sup>	0.8	0.33 <sup>18</sup>	2.6
Others <sup>19</sup>	0.3	1.0 <sup>20</sup>	0.7 <sup>21</sup>	0.2	0.1	0.90 <sup>21</sup>	0.3
<b>Legumes</b>							
Cowpeas	1.3 <sup>22</sup>	0.67 <sup>23</sup>	0.3 <sup>24</sup>	0.8 <sup>25</sup>	1.2	14 <sup>26</sup>	0.1
Groundnuts	0.8 <sup>27</sup>	0.34 <sup>28</sup>	0.3 <sup>29</sup>	1.1 <sup>30</sup>	1.1	1.3 <sup>31</sup>	0.6
Soybeans	0.1	0.73 <sup>32</sup>	0.3 <sup>33</sup>	0.1 <sup>34</sup>	0.1	14 <sup>33</sup>	<0.1
Others <sup>61</sup>	0.4	0.70 <sup>35</sup>	0.3 <sup>35</sup>	0.4 <sup>36</sup>	0.3	8.0 <sup>35</sup>	0.1
<b>Roots and tubers</b>							
Yams	20 <sup>37</sup>	20 <sup>38</sup>	0.1 <sup>39</sup>	0.1	0.9	60 <sup>38</sup>	0.3
Cassavas	16	0.76 <sup>40</sup>	<0.1 <sup>39</sup>	<0.1	21	60 <sup>41</sup>	0.3
Cocoyams	3.4 <sup>37</sup>	6.7 <sup>42</sup>	0.1 <sup>39</sup>	0.1	0.5	60 <sup>41</sup>	0.1
Others <sup>43</sup>	0.7	20 <sup>41</sup>	0.1 <sup>39</sup>	<0.1	<0.1	60 <sup>41</sup>	<0.1
<b>Other crops</b>							
Vegetables <sup>44</sup>	5.1	1.0	0.5	2.6	2.5	10	0.5
Cotton	0.5	0.34 <sup>45</sup>	0.8 <sup>46</sup>	1.1	0.3	1.3 <sup>47</sup>	0.4
Other fibres <sup>48</sup>	<0.1	0.33 <sup>49</sup>	0.9 <sup>49</sup>	<0.1	<0.1	1.0	<0.1
Sesame	0.1	0.48 <sup>50</sup>	0.8 <sup>51</sup>	0.2	<0.1	3.8 <sup>52</sup>	<0.1
Tobacco	<0.1	0.76 <sup>53</sup>	<0.1	<0.1	<0.1	1.0 <sup>54</sup>	<0.1
Sugar cane	2.8	4.0 <sup>55</sup>	0.3 <sup>59</sup>	0.2	0.5	14.5 <sup>56</sup>	0.2
Bananas	4.7	3.1 <sup>57</sup>	<0.1	<0.1	1.5	21 <sup>58</sup>	0.2
Pineapples	0.4	0.7 <sup>59</sup>	<0.1	<0.1	0.6	na <sup>60</sup>	na <sup>60</sup>
<b>Total</b>	<b>74<sup>1</sup></b>			<b>43</b>	<b>49</b>		<b>29</b>

<sup>1</sup> Fresh biomass as reported by FAO (1979a). All other biomass estimates are on a dry-mass basis.

<sup>2</sup> Except as noted, total aerial residue (AR) biomass = (1° harvest biomass)/(1° harvest : AR ratio); 2° harvest biomass = (total AR biomass) × (2° harvest : AR ratio); litter biomass = (total AR biomass) - (2° harvest biomass); root residue (RR) biomass = (1° harvest biomass)/(1° harvest : RR ratio).

<sup>3</sup> 0.13-0.33; Poulain (1980), Balasubramanian and Nnadi (1980), Blondel (1971), Kassam and Stockinger (1973), IRAT (1975).

<sup>4</sup> Poulain (1980), Balasubramanian and Nnadi (1980), Ofori (1980), FAO (1979b); 80% of aerial residue removed over 88% of West Africa.

<sup>5</sup> Poulain (1980).

<sup>6</sup> 0.08-0.36,  $n = 11$ ; Poulain (1980), Balasubramanian and Nnadi (1980), Blondel (1971), Kassam and Stockinger (1973), Goldsworthy (1970), IRAT (1975), Ofori (1972), de Geus (1973).

<sup>7</sup> Includes 11.8 × 10<sup>9</sup> kg chaff taken with 1° harvest (Kowal and Kassam 1978).

<sup>8</sup> 0.42-1.1,  $n = 3$ ; Goldsworthy (1970), Poulain (1980).

<sup>9</sup> Poulain (1980), Balasubramanian and Nnadi (1980), Blondel (1971b), IRAT (1975), Jones (1974).

<sup>10</sup> 80% of aerial residue removed for fodder over 80% of region (Poulain 1980); does not include cob.

<sup>11</sup> Includes 10.9 × 10<sup>9</sup> kg cob taken with 1° harvest (Kowal and Kassam 1978, Drysdale 1965) that was not included in 2° harvest : AR ratio.

<sup>12</sup> Poulain (1980).

<sup>13</sup> Assumes 67% of rice area planted to upland rice (NAS 1974), with upland productivity ≈ 40% of lowland (Kowal and Kassam 1978, da Silva 1978).

<sup>14</sup> 0.49-1.1,  $n = 6$ ; Grist (1975), Wu (1966) in IRRI (1975), Balasubramanian and Nnadi (1980), FAO (1979b).

<sup>15</sup> 22% of husks removed (FAO 1979b) but included in 1° harvest.

<sup>16</sup> Penders (1941).

<sup>17</sup> 0.31-2.9,  $n = 7$ ; Balasubramanian and Nnadi (1980), Wu (1966) in IRRI (1975), Poulain (1980), IRAT (1975).

<sup>18</sup> Penders (1941), Chang et al. (1973).

<sup>19</sup> Mainly wheat.

<sup>20</sup> FAO (1979b) for wheat, barley, and oats; Balasubramanian and Nnadi (1980) for wheat.

<sup>21</sup> As for millet and sorghum.

<sup>22</sup> Cowpeas not reported separately for 1978 (FAO 1979a, 1980a); estimate based on 1974 cowpea proportion (75%) of "cowpeas + other pulses" (FAO 1975).

<sup>23</sup> Balasubramanian and Nnadi (1980), Dart et al. (1977), Eaglesham et al. (1977).

<sup>24</sup> As for groundnuts (Balasubramanian and Nnadi 1980).

<sup>25</sup> Includes 0.20 × 10<sup>9</sup> kg shells; grain = ≈ 87% of pod (Dart et al. 1977, Eaglesham et al. 1977, Akinola and Davies 1978).

<sup>26</sup> 1.2-1.5; Dart et al. (1977), Eaglesham et al. (1977).

<sup>27</sup> Kernels only; kernels = 65% of pod (de Geus 1973, FAO 1979a).



*sagittifolium*) account for 20–30% of the region's protein production, and various other protein sources provide another 5% (FAO 1979a). Plantains, bananas, and sugarcane (*Saccharum* sp.) are also important West African crops. Perennial crops include cacao, coffee (*Coffea* spp.), oil palm, coconut (*Cocos nucifera*), rubber (*Hevea brasiliensis*), and citrus (*Citrus* spp.); cacao and coffee together with groundnuts make up the bulk of West Africa's agricultural exports (FAO 1979b).

Rates of nitrogen flux through these crops, and in particular the fates of the nitrogen contained in yields and in harvest residues, have important consequences for crop productivity. A hectare of cassava that yields  $10^4$  kg fresh roots, for example, commonly removes  $\approx 30$  kg of nitrogen with the harvested crop. In the absence of significant fertilizer inputs, this loss can represent a substantial drain on the system's nitrogen store that is not likely to be fully replaced by nitrogen deposition and nitrogen fixation inputs during a following nonlegume crop cycle. Additionally, another 30 kg/ha remain in the aboveground crop residues, and further nitrogen losses occur when this residue is not left to decompose in situ. Such is the case in most of West Africa: most crop residues are removed for fuel or building material, or used for fodder for farmyard animals or tethered livestock. The residue not removed

is commonly burned before planting the next crop in order to clear the field and inhibit insect pests (Kowal and Kassam 1978, Nnadi and Balasubramanian 1978a, FAO 1979g, Balasubramanian and Nnadi 1980, Mokuwunye 1980, Ofori 1980, Poulain 1980). Plowing crop residues into the soil, as is commonly practiced in temperate agriculture, is generally precluded in West Africa by hard-packed soil in the north and by the absence of draft animals in the south.

Crop nitrogen budgets for temperate regions are usually estimated by extrapolating nitrogen pools and fluxes per unit area of monoculture to the regional level using estimates of the area under the particular crop. In West Africa and most tropical regions, however, such a procedure is impractical because of intercropping and differential planting densities. In multiple crop systems, the density of a given crop species may vary by an order of magnitude or more from one field to another even within the same watershed. Consequently, we have used published estimates of regional crop production to estimate the nitrogen removed in annual crop yields, and then used harvest indices (fresh yield: dry residue ratios) to estimate harvest residue biomass and nitrogen pools. Perennial crops tend to be planted at more constant densities than annual crops and in only 1–2 vegetation zones, so we have extrapolated

←

<sup>28</sup>  $n = 2$ ; Nnadi et al. (1976), Balasubramanian and Nnadi (1980).

<sup>29</sup> 75% of residue removed for fodder  $\approx 40\%$  of time (Poulain 1980, Balasubramanian and Nnadi 1980, Kowal and Kassam 1978, Nnadi et al. 1976, Ofori 1980, FAO 1979b).

<sup>30</sup> Includes  $0.40 \times 10^9$  kg shells.

<sup>31</sup> Poulain (1980).

<sup>32</sup> 0.38–0.91,  $n = 3$ ; Boakyee-Boateng and Hume (1975), Johnson et al. (1975), Kang (1975).

<sup>33</sup> As for cowpeas (Balasubramanian and Nnadi 1980), but ratio does not include shells.

<sup>34</sup> Includes  $0.04 \times 10^9$  kg shells at groundnut shelling efficiency; see footnote 33.

<sup>35</sup> Ohlrogge and Kamprath (1968); ratio does not include shells.

<sup>36</sup> Includes  $0.21 \times 10^9$  kg shells; bambara groundnut grain = 75% of pod (Kay 1979); see footnote 35.

<sup>37</sup> Not reported separately for 1978 (FAO 1979a, 1980a); based on 1974 proportion of yam (84.7%) + cocoyam (14.9%) + other (0.4%) (FAO 1975).

<sup>38</sup> Sobulo (1972).

<sup>39</sup> Estimated from Balasubramanian and Nnadi (1980).

<sup>40</sup>  $n = 2$ ; Kay (1973), Kowal and Kassam (1978).

<sup>41</sup> As for yams.

<sup>42</sup> De la Pena and Plucknett (1972) if tuber = 72% moisture (Kay 1973).

<sup>43</sup> Includes sweet potatoes, potatoes, and others.

<sup>44</sup> Does not include legumes or tubers.

<sup>45</sup> 0.18–0.67,  $n = 22$ ; Deat and Sement (1974), Poulain (1980), Balasubramanian and Nnadi (1980).

<sup>46</sup> Balasubramanian and Nnadi (1980), FAO (1979b).

<sup>47</sup> Poulain (1980).

<sup>48</sup> Kenaf and roselle mainly.

<sup>49</sup> Kowal and Kassam (1978).

<sup>50</sup> 0.31–0.58,  $n = 5$ ; van Rheenan (1973), Sen and Lahiri (1960), Weiss (1971), Bascones and Lopez Ritas (1961).

<sup>51</sup> As for cotton, once threshed in field.

<sup>52</sup> 2.5–4.9,  $n = 4$ ; Sen and Lahiri (1960), Weiss (1971), Bascones and Lopez Ritas (1961).

<sup>53</sup> Akehurst (1968), Kowal and Kassam (1978), Bascones and Lopez Ritas (1961).

<sup>54</sup> Based on 2:1 shoot:root ratio; shoot biomass = (1° harvest biomass less 23% moisture) plus total aerial residue.

<sup>55</sup> FAO (1979b).

<sup>56</sup> Based on 15:1 shoot:root ratio (Humber 1963 in Ruschel et al. 1978); shoot biomass = (1° harvest biomass less 23% moisture) plus total aerial residue.

<sup>57</sup> 1.4–3.9,  $n = 3$ ; Burenrich (1913 in Jacob and Uexküll 1963), Baillon et al. (1933), Marten-Prevel et al. (1968).

<sup>58</sup> Baillon et al. (1933) assuming roots turn over once every 4 yr (Wills 1962, Williams 1975).

<sup>59</sup> Penders (1941); includes roots and assumes 2-yr crop.

<sup>60</sup> Included in aerial residue.

<sup>61</sup> Mainly bambara groundnut.

TABLE 7. Nitrogen in annual crop biomass and its fate. Primary harvest values for % N are on a yield mass basis (8–15% moisture for grains, 70–90% for roots and tubers); other values are on dry mass basis. na = not available.

Crop	Primary harvest N <sup>1</sup>					Secondary harvest N <sup>1</sup>		
	Bio- mass (%)	N (10 <sup>6</sup> kg)	Fate			Bio- mass (%)	N (10 <sup>6</sup> kg)	Fodder <sup>4</sup> (10 <sup>6</sup> kg)
			Consumed (10 <sup>6</sup> kg)	Seed <sup>2</sup> (10 <sup>6</sup> kg)	Exported <sup>3</sup> (10 <sup>6</sup> kg)			
<b>Cereals</b>								
Millet	4.4 <sup>6</sup>	292	289	2.9	<0.1	0.7 <sup>7</sup>	126	63
Sorghum	3.0 <sup>9</sup>	152	151	1.5	<0.1	0.7 <sup>10</sup>	107	54
Maize	2.6 <sup>11</sup>	84	83	0.8	<0.1	0.7 <sup>12</sup>	12	5.8
Rice (lowland)	1.8 <sup>13</sup>	43	42	0.4	<0.1	na	<0.1	<0.1
Rice (upland)	1.8 <sup>13</sup>	16	16	0.2	<0.1	na	<0.1	<0.1
Others	2.2 <sup>16</sup>	5.5	5.4	0.1	<0.1	0.7 <sup>17</sup>	1.2	0.6
<b>Legumes</b>								
Cowpeas	3.6 <sup>18</sup>	48	47	0.5	<0.1	1.8 <sup>19</sup>	14	7.1
Groundnuts	4.3 <sup>22</sup>	32	17	0.3	15 <sup>23</sup>	1.5 <sup>24</sup>	17	8.3
Soybeans	6.3 <sup>27</sup>	4.4	4.4	<0.1	<0.1	0.9 <sup>28</sup>	0.6	0.2
Others	4.3 <sup>31</sup>	17	16	0.2	0.3 <sup>32</sup>	1.3 <sup>33</sup>	4.9	1.7
<b>Roots and tubers</b>								
Yams	0.4 <sup>35</sup>	75	74	0.8	<0.1	2.6 <sup>36</sup>	2.6	1.3
Cassavas	0.3 <sup>38</sup>	43	43	<0.1	<0.1	na	<0.1	<0.1
Cocoyams	0.3 <sup>41</sup>	11	11	0.1	<0.1	2.6 <sup>42</sup>	1.3	0.7
Others	0.3 <sup>44</sup>	2.1	2.1	<0.1	<0.1	1.8 <sup>44</sup>	<0.1	<0.1
<b>Other crops</b>								
Vegetables	0.2 <sup>45</sup>	7.6	7.5	0.1	<0.1	2.0 <sup>46</sup>	52	26
Cotton	2.9 <sup>48</sup>	14	13	0.1	0.7	1.3 <sup>49</sup>	14	7.8
Other fibers	0.5	<0.1	<0.1	<0.1	<0.1	1.0	0.2	0.1
Sesame	3.7 <sup>51</sup>	3.3	3.3	<0.1	<0.1	0.9 <sup>52</sup>	1.3	0.7
Tobacco	2.0 <sup>54</sup>	0.4	0.4	<0.1	<0.1	na	<0.1	<0.1
Sugar cane	0.1 <sup>55</sup>	3.0	3.0	<0.1	<0.1	0.2 <sup>56</sup>	0.4	<0.1
Bananas	0.4 <sup>57</sup>	19	19	<0.1	<0.1	na	<0.1	<0.1
Pineapples	0.1 <sup>59</sup>	0.3	0.3	<0.1	<0.1	na	<0.1	<0.1
<b>Total</b>		<b>870</b>	<b>846</b>	<b>8.0</b>	<b>16</b>		<b>354</b>	<b>177</b>

<sup>1</sup> See Table 6 for biomass.<sup>2</sup> Assumes 1% of crops return as seed.<sup>3</sup> FAO (1979b).<sup>4</sup> Assumes 50% used as fodder for farmyard animals, 40% burned for fuel at 100% burn efficiency, and 10% returned to field with household wastes (Poulain 1980, FAO 1979g, 1980b, Balasubramanian and Nnadi 1980, Nnadi and Balasubramanian 1978a), except where used as processing fuel (100% burned).<sup>5</sup> Assumes 50% used as fodder, 40% burned in field at 90% burn efficiency, and remainder either left in field or used as building material eventually returned to field (Poulain 1980, FAO 1979g, 1980b, Nnadi and Balasubramanian 1978a, Balasubramanian and Nnadi 1980, Kowal and Kassam 1978).<sup>6</sup> Blondel (1971), IRAT (1975); 4.1–4.5% N, *n* = 4.<sup>7</sup> French (1943), Poulain (1980), Balasubramanian and Nnadi (1980), Singh and Balasubramanian (1980b); 0.65–0.83% N, *n* = 5.<sup>8</sup> Poulain (1980), Ganry et al. (1978a, b); 0.41–0.90% N, *n* = 2.<sup>9</sup> Poulain (1980), Gigou (1980), Blondel (1971), IRAT (1975); 1.3–3.8% N, *n* = 4.<sup>10</sup> Poulain (1980), Balasubramanian and Nnadi (1980), Singh and Balasubramanian (1980b); 0.29–1.5% N, *n* = 4.<sup>11</sup> Blondel (1971), IRAT (1975); 2.4–2.7% N, *n* = 3.<sup>12</sup> French (1943), Poulain (1980), Balasubramanian and Nnadi (1980), Singh and Balasubramanian (1980b); 0.51–0.80% N, *n* = 4.<sup>13</sup> Blondel (1971), IRAT (1975), Grist (1975); 0.96–2.5% N, *n* = 4.<sup>14</sup> Grist (1975), Balasubramanian and Nnadi (1980), Singh and Balasubramanian (1980b); 0.45–0.58% N, *n* = 4.<sup>15</sup> Grist (1975).<sup>16</sup> Wheat; French (1943); 2.0–2.4% N, *n* = 3.<sup>17</sup> As for sorghum.<sup>18</sup> IBAN (1936), Purseglove (1968), Nnadi et al. (1976), Rachie and Roberts (1974), Eaglesham et al. (1977), Kay (1979); 3.0–4.0% N, *n* = 9, assumed 10% moisture if dry mass basis.<sup>19</sup> Assumed 13% of secondary harvest = shells at % N for groundnut shells, remainder at litter % N.<sup>20</sup> French (1943), Dart et al. (1977), Eaglesham et al. (1977), Kay (1979); 1.0–2.9% N, *n* = 5.<sup>21</sup> Nnadi et al. (1976), Nnadi and Balasubramanian (1978b), Dart et al. (1977), Eaglesham et al. (1977).<sup>22</sup> Purseglove (1968), Nnadi et al. (1976), IBAN (1936); 3.7–4.9% N, *n* = 10, grain only.<sup>23</sup> 2.5 × 10<sup>6</sup> kg N as groundnuts, 12.4 × 10<sup>6</sup> kg N as cake and meal (at 7.4% N; IBAN 1936); from FAO (1979b).<sup>24</sup> Assumed 35% of secondary harvest = shells at 0.85% N (IBAN 1936, Gillier 1966, Balasubramanian and Nnadi 1980, Singh and Balasubramanian 1980b; 0.73–1.0% N, *n* = 7), remaining 65% at litter % N.<sup>25</sup> Poulain (1980), Balasubramanian and Nnadi (1980), French (1943); 1.3–2.3% N, *n* = 3.<sup>26</sup> Poulain (1980), Balasubramanian and Nnadi (1980), Nnadi and Balasubramanian (1978b); 1.2–3.5% N, *n* = 3.<sup>27</sup> IBAN (1936), Purseglove (1968), Kang (1975); 5.8–8.2% N, *n* = 6.

TABLE 7. Continued.

Secondary harvest N <sup>1</sup>			Litter N				Belowground residue	
Fate <sup>4</sup>		Bio-mass (%)	N (10 <sup>6</sup> kg)	Forage (10 <sup>6</sup> kg)	Fate <sup>5</sup>		Bio-mass (%)	N (10 <sup>6</sup> kg)
Burned (10 <sup>6</sup> kg)	Returned (10 <sup>6</sup> kg)				Burned (10 <sup>6</sup> kg)	Returned (10 <sup>6</sup> kg)		
50	13	0.77	54	27	19	7.5	0.6 <sup>8</sup>	56
43	11	0.7 <sup>10</sup>	30	15	11	4.1	0.6 <sup>8</sup>	32
4.6	1.2	0.7 <sup>12</sup>	21	11	7.6	3.0	0.6	9.6
<0.1	<0.1	0.5 <sup>14</sup>	14	7.2	5.1	2.0	0.24 <sup>15</sup>	17.3
<0.1	<0.1	0.5 <sup>14</sup>	4.0	2.0	1.4	0.6	0.24 <sup>15</sup>	6.2
0.5	0.1	0.7 <sup>17</sup>	0.5	0.3	0.2	0.1	0.6	1.7
5.7	1.4	1.9 <sup>20</sup>	23	11	8.2	3.2	1.1 <sup>21</sup>	1.0
6.6	1.7	1.8 <sup>25</sup>	20	9.9	7.1	2.8	2.1 <sup>26</sup>	12
0.1	<0.1	0.9 <sup>29</sup>	0.5	0.3	0.2	0.1	1.2 <sup>30</sup>	0.5
1.3	0.3	1.5 <sup>34</sup>	5.9	2.9	2.4	0.6	1.6 <sup>34</sup>	0.8
1.0	0.3	0.9 <sup>37</sup>	7.7	3.9	2.8	1.1	0.77 <sup>37</sup>	2.5
<0.1	<0.1	0.3 <sup>39</sup>	52	26	19	7.3	0.45 <sup>40</sup>	1.2
0.5	0.1	1.8 <sup>43</sup>	8.3	4.2	3.0	1.2	0.32 <sup>44</sup>	0.2
<0.1	<0.1	1.0 <sup>44</sup>	0.3	0.2	0.1	0.0	0.36 <sup>44</sup>	<0.1
21	5.2	2.0 <sup>46</sup>	50	25	18	7.0	1.3 <sup>47</sup>	6.6
6.2	1.6	1.3 <sup>50</sup>	3.6	1.8	1.3	0.5	1.0 <sup>50</sup>	3.6
0.1	<0.1	na	<0.1	<0.1	<0.1	<0.1	0.6	0.1
0.5	0.1	0.9 <sup>52</sup>	0.3	0.2	0.1	<0.1	0.37 <sup>53</sup>	0.1
<0.1	<0.1	1.9 <sup>54</sup>	0.6	0.3	0.2	0.1	1.0	0.2
0.4	<0.1	0.2 <sup>56</sup>	1.0	0.5	0.4	0.1	1.0	0.9
<0.1	<0.1	0.6 <sup>57</sup>	9.2	4.6	3.3	1.3	0.6	1.4
<0.1	<0.1	0.2 <sup>60</sup>	1.1	0.6	0.4	0.1	na <sup>61</sup>	na <sup>61</sup>
142	35		306	154	111	43		154

<sup>28</sup> As for groundnuts calculation.  
<sup>29</sup> Morrison (1954), Ohlrogge (1960), de Mooy et al. (1973); 0.44–2.0% N, *n* = 5.  
<sup>30</sup> Nnadi and Balasubramanian (1978*b*), Hanway and Weber (1971); 0.9–1.4% N, *n* = 2.  
<sup>31</sup> Mean of other legumes + bambara groundnut (2.8% N; Kay 1979).  
<sup>32</sup> May include cowpeas and soybeans (FAO 1979*b*).  
<sup>33</sup> Assumed 25% = shells at % N for groundnut shells, remainder at litter % N.  
<sup>34</sup> Mean of other legumes.  
<sup>35</sup> Kay (1973), Sobulo (1972), Doku (1967); 0.32–0.50% N, *n* = 3; assumed 65% moisture where necessary.  
<sup>36</sup> French (1943); tops.  
<sup>37</sup> Sobulo (1972).  
<sup>38</sup> IBAN (1936), du Fournet et al. (1957) in de Geus (1973), Doku (1967), Johnson and Raymond (1965), de Geus (1973); 0.11–0.68% N, *n* = 11.  
<sup>39</sup> du Fournet et al. (1957) in de Geus (1973).  
<sup>40</sup> Howeler (1981); 0.17–0.93% N.  
<sup>41</sup> Doku (1967), Kay (1973); 0.28–0.35% N, *n* = 2.  
<sup>42</sup> As for yams.  
<sup>43</sup> de la Pena and Plucknett (1972); 1.6–2.1% N, *n* = 2.  
<sup>44</sup> Mean of other roots and tubers.  
<sup>45</sup> IBAN (1936), USDA (1971); 0.04–0.32% N, *n* = 6 crops.  
<sup>46</sup> Greenwood et al. (1980); 0.7–3.5% N, *n* = 12.  
<sup>47</sup> Greenwood et al. (1980), *n* = 7.  
<sup>48</sup> IBAN (1936), Purseglove (1968), Prentice (1972), Deat and Sement (1974), Deat et al. (1976); 1.3–4.0% N, *n* = 16.  
<sup>49</sup> Poulain (1980), Balasubramanian and Nnadi (1980), Singh and Balasubramanian (1980*b*); 0.66–1.9% N, *n* = 20.  
<sup>50</sup> Poulain (1980).  
<sup>51</sup> IBAN (1936), Bascones and Lopez Ritas (1961), van Rheenan (1973); 2.9–5.4% N, *n* = 6.  
<sup>52</sup> Bascones and Lopez Ritas (1961), Sen and Lahiri (1960), 0.78–0.94% N, *n* = 2.  
<sup>53</sup> Bascones and Lopez Ritas (1961).  
<sup>54</sup> Akehurst (1968).  
<sup>55</sup> Jacob and von Uexküll (1963), FAO (1965, 1979*b*); 0.06–0.12% N, *n* = 4.  
<sup>56</sup> Based on cane N: top N ratio of 0.14:0.24 (Morrison 1954); cane % N = 0.11 (footnote 55).  
<sup>57</sup> IBAN (1936), Marten-Prevel et al. (1968); 0.05–1.3% N, *n* = 7.  
<sup>58</sup> Jacob and von Uexküll (1963).  
<sup>59</sup> IBAN (1936), Penders (1941), Jacob and von Uexküll (1963); 0.072–0.083% N, *n* = 4.  
<sup>60</sup> Penders (1941).  
<sup>61</sup> Included in aerial residue.

TABLE 8. Area covered by, and maximum standing biomass and nitrogen contents of, the major perennial crops. All values are expressed on a dry-matter basis.

Crop	Area planted (10 <sup>6</sup> ha)	Leaf		Wood		Roots		Inflorescence and fruit		Total N	
		Biomass (10 <sup>3</sup> kg/ha)	N (%)	Biomass (10 <sup>3</sup> kg/ha)	N (%)	Bio-mass (10 <sup>3</sup> kg/ha)	N (%)	Bio-mass (10 <sup>3</sup> kg/ha)	N (%)	Local (kg/ha)	Re-gional (10 <sup>6</sup> kg)
		Coffee	1.0 <sup>1</sup>	0.2 <sup>2</sup>	2.0 <sup>2</sup>	0.4 <sup>2</sup>	0.50 <sup>2</sup>	0.5 <sup>2</sup>	1.8 <sup>2</sup>	0.8 <sup>3</sup>	0.67 <sup>4</sup>
Cacao	2.9 <sup>1</sup>	0.6 <sup>6</sup>	1.8 <sup>6</sup>	6.8 <sup>6</sup>	0.80 <sup>7</sup>	3.6 <sup>6</sup>	1.2 <sup>6</sup>	0.1 <sup>3</sup>	1.1 <sup>8</sup>	103	294
Citrus	0.02 <sup>9</sup>	1.6 <sup>10</sup>	2.1 <sup>11</sup>	5.8 <sup>10</sup>	0.44 <sup>11</sup>	2.1 <sup>10</sup>	0.70 <sup>11</sup>	0.4	2.6 <sup>12</sup>	81	2
Rubber	0.13 <sup>13</sup>	6.3 <sup>14</sup>	2.8 <sup>14</sup>	290 <sup>14</sup>	0.45 <sup>14</sup>	59 <sup>15</sup>	0.44 <sup>14</sup>	0.2 <sup>14</sup>	1.06 <sup>14</sup>	1738	226
Oil palm and coconut	1.2 <sup>16</sup>	16.1 <sup>17</sup>	1.2 <sup>17</sup>	38 <sup>17</sup>	0.48 <sup>17</sup>	17 <sup>17</sup>	0.48 <sup>18</sup>	3.6 <sup>18</sup>	0.83 <sup>19</sup>	488	591
Total	5.3										1134

<sup>1</sup> FAO (1979a).<sup>2</sup> Roskoski et al. (1982) assuming 1200 trees/ha.<sup>3</sup> Calculated from inflorescence and fruit % N and N yield (kg/ha).<sup>4</sup> From Table 5 assuming 8.2% moisture in primary harvest and a 1° harvest residue ratio of 0.35.<sup>5</sup> Inflorescence and fruit N yield (kg/ha) based on primary harvest biomass (Table 5) and area covered (FAO 1980a).<sup>6</sup> Roskoski et al. (1982), assuming 1500 trees/ha (Urquhart 1961).<sup>7</sup> Boyer (1973), Roskoski et al. (1982); 0.29–1.3% N, *n* = 2.<sup>8</sup> Boyer (1973).<sup>9</sup> Based on regional production (FAO 1979a) and average yield of  $\approx 16 \times 10^3$  kg/ha (Ayers and Branson 1973; unfertilized California trees).<sup>10</sup> Cameron and Compton (1945), assuming 100 trees/ha.<sup>11</sup> Cameron and Compton (1945).<sup>12</sup> Cameron and Compton (1945), FAO (1970), Hume (1957), Wallace et al. (1951); 0.85–3.6% N, *n* = 8.<sup>13</sup> Based on regional production (FAO 1979a) and average latex yields of  $\approx 1400$  kg/ha (Shorrocks 1965b: 1700 kg/ha; Rosenquist 1966 in de Geus 1973: 1430 kg/ha; de Geus 1973: 560–1700 kg/ha).<sup>14</sup> Shorrocks (1965a), assuming that 25% of all trees are <10 yr old, and 75% are 10–33 yr.<sup>15</sup> Shorrocks (1965a); roots = 16.5% total tree (15.8–17.8%, *n* = 4).<sup>16</sup> Based on regional production (FAO 1979a); for oil palm, average fresh kernel yields of  $\approx 0.46 \times 10^3$  kg/ha (Godin and Spensley 1971:  $0.54 \times 10^3$  kg/ha; Johnson and Raymond 1954:  $0.18 \times 10^3$  kg/ha; Georgi 1931:  $0.41 \times 10^3$  kg/ha); for coconut, average harvest yield (whole nut less husk) of  $\approx 2500$  kg/ha (copra 400 kg/ha  $\times$  6 husked nuts/kg copra [Purseglove 1975]  $\times$  fresh matter 1 kg/nut [Child 1974]).<sup>17</sup> Tinker and Smilde (1963) for oil palm.<sup>18</sup> Rees and Tinker (1963) for oil palm.<sup>19</sup> Georgi (1931); 0.55–1.1% N, *n* = 2.

typical local pools and fluxes for perennial crops to the regional level based on published estimates of cultivated areas.

West African annual crops yielded  $\approx 77 \times 10^9$  kg of primary harvest fresh biomass in 1978 (Table 6). Another  $122 \times 10^9$  kg of dry biomass were produced as nonyield biomass or aerial and root residue, with  $\approx 35\%$  of this removed from the fields in the form of secondary harvest products such as pod walls, shells, and chaff. West African crops vary substantially in their capacities to produce residue; ratios of primary harvest biomass to aerial residue range from <1.0 for most cereals and grain legumes to >19 for some roots and tubers. Over 70% of the aerial residue produced in the region is derived from millet, sorghum, and cassava crops.

Associated with the annual crop yield removed from the region's fields in 1978 were  $\approx 870 \times 10^6$  kg N (Table 7). Most of the nitrogen in these yields was consumed within the region, although some ( $\approx 16 \times 10^6$  kg) was exported and a small portion ( $\approx 1\%$ ) was presumably set aside for return to the soil the following year as seed. Another  $660 \times 10^6$  kg were immobilized

in aerial residue,  $\approx 50\%$  of which was harvested with the primary yield as secondary harvest products. Almost half of all aerial residue nitrogen ( $\approx 331 \times 10^6$  kg) was probably consumed by domestic livestock either fed secondary harvest products directly or grazed in the harvested fields. Most of the remaining aerial residue N was likely burned ( $\approx 253 \times 10^6$  kg), either for fuel or in the field, but some ( $\approx 78 \times 10^6$  kg) was left on the soil surface to eventually mineralize. Aerial residue used for building materials (e.g., thatched roofs) and fencing is presumed to eventually burn or decompose in the field. Belowground crown and root residue contained  $\approx 120 \times 10^6$  kg N, all of which remained in the soil.

Perennial crops covered an effective area of  $\approx 5.3 \times 10^6$  ha of West Africa in 1978, principally in the coastal regions. As much as  $1.13 \times 10^9$  kg of nitrogen were immobilized in the standing biomass of these crops at one time during the year (Table 8); on a regional basis over half of this N was immobilized in aboveground wood, though this proportion varied substantially by crop. Rubber trees, for example, immobilize in wood around  $1.3 \times 10^3$  kg/ha, whereas oil palm and coconut

trees immobilize  $\approx 0.2 \times 10^3$  kg/ha. Collectively, N removed in perennial crops in 1978 was  $\approx 44 \times 10^6$  kg in their primary yield,  $\approx 33 \times 10^6$  kg in harvest residue, and  $\approx 104 \times 10^6$  kg in litterfall and throughfall leachates (Table 9). Of that N removed by harvest residue and litterfall,  $\approx 35\%$  ( $75 \times 10^6$  kg) was subsequently volatilized when burned, and the remainder returned to the soil (Table 10).

The nitrogen content of secondary producers (principally humans, terrestrial vertebrates, and fish) in West Africa, including those in noncultivated systems, was  $\approx 23 \times 10^6$  kg in 1978 (Table 11). Cattle and other livestock accounted for  $\approx 47\%$  of this pool, humans 31%, and inland fish most of the remainder. Of N in the secondary producer pool,  $\approx 2.8 \times 10^6$  kg was consumed by humans. Population growth (FAO 1980a) between 1977 and 1978 indicates that  $\approx 0.2 \times 10^6$  kg were immobilized into humans in 1978 (see Table 11). Likewise, about  $0.1 \times 10^6$  kg appears to have been immobilized in the growing livestock population (FAO 1980a).

#### *Nitrogen in noncultivated systems*

Approximately  $63 \times 10^9$  kg of nitrogen were immobilized in the vegetation and litter biomass of noncultivated ecosystems in West Africa in 1978 (Table 12). Almost half of this was in early secondary forest growth, with  $\approx 50\%$  of the remainder in late successional savanna systems and 30% in older forests. Nitrogen flux estimates for noncultivated systems are particularly limited by a restricted data base, but rough extrapolations (Table 13) show that  $\approx 22 \times 10^9$  kg were taken up by the West African native vegetation in 1978. Early secondary forest vegetation accounted for  $\approx 50\%$  of this uptake; of the remainder,  $\approx 60\%$  was removed by late successional savanna vegetation and  $< 10\%$  by older forests. On a regional level, both total biomass nitrogen and net nitrogen uptake in mature Guinea Savanna Woodland vegetation exceeded that for all other systems except early secondary Lowland Rain Forest, although this rank was largely the result of geographic size. At the local level rankings by uptake generally followed woody biomass content, with forests  $>$  derived savanna grassland  $>$  Guinea savanna woodland  $>$  Sahel bushland  $>$  subdesert grassland.

Lakes cover  $\approx 8.0 \times 10^6$  ha of West Africa. There is little information available regarding nitrogen within these lakes or within tropical lakes in general. However, using Table 14 nitrogen concentration estimates of 0.10% in lake water and 90 kg/ha in the upper 30 cm of lake sediments, we calculate that there were  $\approx 318 \times 10^9$  kg in West African lakes in 1978, of which  $> 99\%$  was in the sediments. Our estimates of  $N_2$  fixation in West African lakes (Table 2) are based on Horne and Viner's (1971) estimate of  $\approx 44$  kg  $\cdot$  ha $^{-1}$   $\cdot$  yr $^{-1}$  for Lake George, Uganda. Nitrogen fixation in temperate lakes ranges to  $\approx 60$  kg  $\cdot$  ha $^{-1}$   $\cdot$  yr $^{-1}$  (Lean et al. 1978).

#### *Nitrogen losses from West Africa*

Nitrogen is lost from West Africa by gaseous, hydrologic, and anthropic pathways. Principal gaseous vectors include  $NO_x$  production via biomass burning and abiotic soil processes,  $N_2$  and  $N_2O$  production by microbes in soils, and  $NH_3$  volatilization from unamended soil, manure, and commercial fertilizer applications.

Fire appears to account for the bulk of all nitrogen lost from the region. Approximately  $8300 \times 10^6$  kg were lost by this pathway in 1978 (Table 15). About 67% of this loss occurred upon clearing and burning forest vegetation,  $< 4\%$  via burning crop residues, and the remainder during near-annual burns of savanna, Sahel, and subdesert systems.

Of the  $185 \times 10^6$  kg N in cleared mature forests, about  $43 \times 10^6$  kg were removed in the 1978 harvest of  $\approx 9.8 \times 10^9$  kg of industrial roundwood (FAO 1979e; assumes a mean wood density of 0.65 [F. Bernhard-Reversat, *personal communication*]). Of that harvested,  $2.4 \times 10^9$  kg was exported (FAO 1979e), representing a nitrogen loss to the region of  $\approx 11 \times 10^6$  kg. The remaining roundwood was presumably consumed within the region, with conversion to  $NO_x$  upon burning the probable eventual fate of the  $33 \times 10^6$  kg N contained therein.

Gaseous losses of N as nitrous oxide ( $N_2O$ ) and  $N_2$  via denitrifiers in West African soils are probably  $\approx 1100 \times 10^6$  kg/yr. Little attention has been paid to denitrification in upland West African soils; as is the case in temperate regions, denitrification in most of the region's systems appears to be a potentially important but poorly quantified nitrogen cycle process.

Volatilization losses of ammonia ( $NH_3$ ) from unfertilized soils in West Africa are probably low, on the order of  $100 \times 10^6$  kg N for 1978. Because ammonia volatilization is not likely to be an important source of nitrogen loss in unfertilized systems with a soil pH below 7 or an intact plant canopy (Denmead et al. 1976), significant local losses of ammonia from uncultivated systems probably occur only in parts of the Guinea savanna, the Sahel, and the subdesert.

Ammonia can also be volatilized from commercial fertilizers and manure, although in West Africa relatively little is lost during commercial fertilizer applications because nitrogen fertilizers are not often applied to West African crops. In Nigeria, for example, where natural gas for fertilizer feedstock is readily available, only 1.5 kg/ha of nitrogen were expected to be applied in this form to cultivable land in 1978 (FDA 1977). Suggested fertilizer application rates for most crops (Singh and Balasubramanian 1980a) exceed this figure by two orders of magnitude. Consequently, ammonia losses from surface applications of urea and inorganic nitrogen fertilizers ( $\approx 13 \times 10^6$  kg N; Table 16) are relatively minor.

TABLE 9. Nitrogen turnover and uptake in major perennial crops. N uptake is the sum of regional values for primary harvest + harvest residue + litterfall + throughfall + net accretion in biomass. Regional litterfall and throughfall values are based on crop extents in Table 8; all biomass values but primary harvest are dry mass basis. PH:HR is the pri-

Crop	Annual N turnover									
	1° harvest removed			Residue removed			Nonwoody litterfall		Woody litterfall	
	N content		PH:HR	N content		Biomass (10 <sup>3</sup> kg/ha)	N content		Biomass (10 <sup>3</sup> kg/ha)	
	Biomass (10 <sup>9</sup> kg) <sup>2</sup>	(%)		(10 <sup>6</sup> kg)	(%)		(%)	(kg/ha)		
Coffee	0.22	1.4 <sup>3</sup>	3.0	0.35 <sup>4</sup>	0.39 <sup>5</sup>	2.4	0.14 <sup>6</sup>	1.5 <sup>7</sup>	2.1	0.04 <sup>8</sup>
Cacao	0.76	3.4 <sup>10</sup>	26	1.0 <sup>11</sup>	1.6 <sup>11</sup>	12	0.38 <sup>6</sup>	1.4 <sup>2</sup>	5.3	0.7 <sup>8</sup>
Citrus	0.34	0.12 <sup>12</sup>	0.4	<0.1	na	<0.1	0.91 <sup>13</sup>	1.6 <sup>13</sup>	14.2	0.6 <sup>8</sup>
Rubber	0.18	0.57 <sup>14</sup>	1.0	<0.1	na	<0.1	5.8 <sup>15</sup>	1.2 <sup>16</sup>	71.7 <sup>17</sup>	1.93 <sup>15</sup>
Oil palm	0.43	1.3 <sup>19</sup>	5.6	0.06 <sup>20</sup>	0.18 <sup>21</sup>	14	7.7 <sup>22</sup>	0.90 <sup>22</sup>	68.9	<0.1
Coconut	0.61 <sup>23</sup>	1.3 <sup>24</sup>	8.0	2.3 <sup>25</sup>	1.4 <sup>24</sup>	3.8	7.7 <sup>26</sup>	0.90 <sup>26</sup>	69	<0.1
Total			44			32				

<sup>1</sup> Turnover plus net accretion in biomass; accretion = (standing biomass N [from Table 8])/(average plant lifetime); assumes no significant net regional N loss by tree or stand replacement. Plant lifetimes are 30 yr for coffee (Purseglove 1968), 30 yr for cacao and citrus, 40 yr for rubber, and 60 yr for oil palm and coconut.

<sup>2</sup> FAO (1980a).

<sup>3</sup> IBAN (1936).

<sup>4</sup> Boyer (1973) with beans = 5% moisture (IBAN 1936).

<sup>5</sup> Bressani et al. (1972) in Elias (1979).

<sup>6</sup> Estimate based on leaf turnover of 60%/yr; see Table 8 for leaf biomass.

<sup>7</sup> Estimate based on 75% pre-abscission % N.

<sup>8</sup> Pruning estimate (wood biomass of 10%/yr).

<sup>9</sup> From Table 8.

<sup>10</sup> Jacob and Uexküll (1963), Adams (1962); 2.4–4.4% N, *n* = 2.

<sup>11</sup> Adams (1962), Boyer (1973), IBAN (1936); 0.81–2.3% N, *n* = 2.

<sup>12</sup> Ayers and Branson (1973), IBAN (1936), Smith and Renner (1954); 0.06–0.16% N.

<sup>13</sup> Wallace et al. (1951), assuming 100 trees/ha.

<sup>14</sup> Beauflis (1955), Shorrocks (1965b), Rosenquist (1966, in Webster and Wilson 1980); 0.47–0.70% N, *n* = 6.

<sup>15</sup> Shorrocks (1965a), including thinned trees.

<sup>16</sup> Shorrocks (1965b).

<sup>17</sup> Includes  $1.6 \times 10^3$  kg N from fruit-fall of  $0.15 \times 10^3$  kg/ha at 1.06% N (Shorrocks 1965a, b).

<sup>18</sup> Shorrocks (1965a).

<sup>19</sup> IBAN (1936).

<sup>20</sup> Georgi (1931), Johnson and Raymond (1954).

<sup>21</sup> Based on total fruit % N = 0.27 (Tinker and Smilde 1963, Georgi 1931, de Geus 1973).

<sup>22</sup> Georgi (1931).

<sup>23</sup> Whole nut less husk.

<sup>24</sup> de Geus (1973), based on nut + husk N content and 10% husk moisture.

<sup>25</sup> Child (1974), Purseglove (1975); 0.61–0.75, *n* = 2.

<sup>26</sup> As for oil palm (Pillai and Davis 1963 in Child 1974).

<sup>27</sup> Regional total N turnover for each crop = 10<sup>6</sup> kg in residue removed plus [(10<sup>6</sup> ha areal extent from Table 8) × (kg/ha in nonwoody litterfall + kg/ha in woody litterfall + kg/ha in throughfall)].

TABLE 10. Fate of nitrogen turned over by major perennial crops.

Crop	1° harvest		2° harvest <sup>1</sup>		Litter <sup>2</sup>	
	Consumed	Exported <sup>3</sup>	Burned	Returned	Burned	Returned
	Nitrogen content (10 <sup>6</sup> kg)					
Coffee	<0.1	3.0 <sup>4</sup>	1.2	1.2	0.2	13
Cacao	2.8	23	6.1	6.1	16	43
Citrus	0.4	0.0	<0.1	<0.1	<0.1	0.5
Rubber	0.3	0.7	<0.1	<0.1	1.1	11
Oil palm	2.6	3.0 <sup>5</sup>	6.8	6.8	33	42
Coconut	7.8	0.1	1.9	1.9	9.0	12
Total	14	30	16	16	59	121

<sup>1</sup> FAO (1979g, 1980b).

<sup>2</sup> Assumes all woody litter and 50% of oil palm and coconut leaf litter burned for fuel (100% burn efficiency).

<sup>3</sup> Biomass from FAO (1979b) and % N from Table 9.

<sup>4</sup> 1978 exports exceeded 1978 production (FAO 1979b); production value (Table 9) used here.

<sup>5</sup> Includes  $1.1 \times 10^6$  kg N exported as oil palm, coconut, and other oil cakes.

TABLE 9. Continued.

mary harvest : Harvest residue ratio. na = not available.

Annual N turnover				Annual N uptake <sup>1</sup>
Woody litterfall		Through-fall N (kg/ha)	Regional total N <sup>27</sup> (10 <sup>6</sup> kg)	
N content (%)	(kg/ha)			Regional total (10 <sup>6</sup> kg/yr)
0.5 <sup>9</sup>	0.2	10	13	19
0.8 <sup>9</sup>	5.6	10	60	107
0.44 <sup>9</sup>	2.6	10	0.6	1.1
0.45 <sup>16</sup>	8.7	10 <sup>18</sup>	12	19
na	<0.1	10	75	102
na	<0.1	10	21	34
			181	282

Nitrogen losses from manure deposited on soil surfaces are by comparison considerable;  $\approx 220 \times 10^6$  kg were lost by this pathway in 1978 (Tables 15 and 16). We estimate, using livestock mass extrapolations (Table 16), that  $\approx 136 \times 10^6$  kg were lost via extensively grazed livestock; this figure compares relatively well with the  $125 \times 10^6$  kg estimated to be lost from grazed systems in Table 15. Humans account for  $\approx 31\%$  of the manure nitrogen produced in the region, vs. 47% for cattle and 11% for sheep and goats, but because only  $\approx 20\%$  of human excrement is available for volatilization on the soil surface (Singh and Balasubramanian 1980a), humans are a minor direct ammonia source.

Nitrogen is also lost by NO<sub>2</sub> and NO emissions from soils, though this NO<sub>x</sub>-N flux remains very poorly

understood in general. Makarov (1969) and Kim (1973) estimated fluxes of 0.3–7.0 and 1.7–4.0 g·m<sup>-2</sup>·s<sup>-1</sup>, respectively, for temperate soils. If these N loss rates are extrapolated to 90 d of equivalent activity per year (0.03–0.71 kg·ha<sup>-1</sup>·yr<sup>-1</sup>), and to all of nondesert terrestrial West Africa (418 × 10<sup>6</sup> ha), then 13–304 × 10<sup>6</sup> kg could have been lost by this pathway in 1978. Some portion of this may be returned via wet precipitation to locations near the point of origin.

We have estimated hydrologic losses of nitrogen from West Africa using Niger River fluxes, since more complete data are unavailable. On average,  $\approx 2.5$  kg of mineral-N and 1.7 kg organic-N were lost per hectare of the 209 × 10<sup>6</sup>-ha Niger River watershed in 1978 (Table 17). This watershed includes portions of all vegetation zones, so that this mean loss estimate may be a reasonable figure for the entire region less desert and subdesert areas. Extrapolation of this N discharge rate suggests that  $\approx 1500 \times 10^6$  kg/yr were lost to marine systems by river flow in 1978.

Although on a local scale, erosion, runoff, and leaching N-losses can far exceed our estimated 5.1 kg·ha<sup>-1</sup>·yr<sup>-1</sup> regional average (e.g., Fournier 1967, Lal 1977, Roose 1980), most local erosion and runoff losses probably represent redistributions of nitrogen within the region, and high solute losses in wet areas are offset by low rates of loss in drier regions. Some of the nitrogen redistributed by erosion may be immobilized in sediments of lakes and behind recently constructed dams, and may thus be effectively withdrawn from the terrestrial cycle, but the extent of such sedimentation is not presently known.

TABLE 11. Nitrogen in secondary producers and human consumption of secondary producers in West Africa in 1978. na = not available or not applicable; LM = live mass.

Component	Standing pool				Human consumption	
	Pop'n <sup>1</sup> (10 <sup>6</sup> )	LM each (kg)	LM total (10 <sup>9</sup> kg)	N total <sup>2</sup> (10 <sup>6</sup> kg)	LM total <sup>3</sup> (10 <sup>9</sup> kg)	N total (10 <sup>6</sup> kg)
Human	132	55	7.3	7.2	na	na
Livestock						
Cattle	30	250 <sup>4</sup>	7.6	7.6	1.06	1.1
Sheep	30	25 <sup>4</sup>	0.76	0.8	0.19	0.2
Goats	48	19 <sup>4</sup>	0.90	0.9	0.34	0.3
Swine	3.2	100 <sup>4</sup>	0.32	0.3	0.17	0.2
Asses	2.2	140	0.31	0.3	<0.1	<0.1
Horses	1.0	165 <sup>4</sup>	0.17	0.2	<0.1	<0.1
Camels	1.2	200	0.25	0.3	<0.1	<0.1
Poultry	178	2	0.36	0.4	0.47	0.5
Wild vertebrates	na	na	0.1	0.1	<0.1	<0.1
Inland fish	na	na	5.0 <sup>5</sup>	5.0	0.5 <sup>6</sup>	0.5
Total				23		2.8

<sup>1</sup> FAO (1979a).<sup>2</sup> All animals assumed to be 0.1% N on a live mass basis.<sup>3</sup> Based on dressed mass (FAO 1979a) and dressed mass : live mass ratios of 0.43 (cattle), 0.50 (sheep), and 0.49 (goats) (FAO 1971) and 0.50 (all others).<sup>4</sup> FAO (1971).<sup>5</sup> Standing stock assumed = 10 × annual catch.<sup>6</sup> FAO (1979c).

TABLE 12. Vegetation biomass and nitrogen contents in noncultivated West African systems. Footnotes follow Table 13; na = not applicable.

System	Leaves, flowers and fruits		Wood		Roots		Litter
	Biomass (10 <sup>3</sup> kg/ha)	N (%)	Biomass (10 <sup>3</sup> kg/ha)	N (%)	Biomass (10 <sup>3</sup> kg/ha)	N (%)	Biomass (10 <sup>3</sup> kg/ha)
Lowland rain forest							
Early successional	5.7 <sup>1</sup>	2.2 <sup>1</sup>	72 <sup>1</sup>	0.26 <sup>1</sup>	26 <sup>1</sup>	0.69 <sup>1</sup>	7.4 <sup>1</sup>
Mid-successional	6.5 <sup>2</sup>	2.2 <sup>2</sup>	117 <sup>2</sup>	0.26 <sup>2</sup>	31 <sup>2</sup>	0.47 <sup>2</sup>	5.6 <sup>2</sup>
Mature	10 <sup>4</sup>	2.2	467 <sup>5</sup>	0.50 <sup>6</sup>	57 <sup>7</sup>	0.58	5.0
Semideciduous forest							
Early successional	5.2 <sup>11</sup>	1.6 <sup>12</sup>	28 <sup>13</sup>	0.55 <sup>14</sup>	11 <sup>15</sup>	1.1 <sup>15</sup>	10.2 <sup>16</sup>
Mid-successional	5.6 <sup>19</sup>	2.5 <sup>19</sup>	112 <sup>19</sup>	0.32 <sup>19</sup>	14 <sup>20</sup>	0.9 <sup>20</sup>	5.6 <sup>19</sup>
Mature	16 <sup>22</sup>	2.0 <sup>23</sup>	150 <sup>24</sup>	0.37 <sup>25</sup>	25 <sup>26</sup>	0.86 <sup>2</sup>	3.9 <sup>27</sup>
Derived savanna grassland							
Early successional	8.2 <sup>30</sup>	1.1 <sup>31</sup>	2.4 <sup>32</sup>	0.81 <sup>33</sup>	2.7 <sup>34</sup>	0.66 <sup>35</sup>	1.2 <sup>36</sup>
Late successional	4.8 <sup>39</sup>	1.4 <sup>40</sup>	28 <sup>41</sup>	0.35 <sup>42</sup>	28 <sup>43</sup>	0.63 <sup>44</sup>	2.8 <sup>45</sup>
Guinea savanna woodland							
Early successional	9.6 <sup>48</sup>	0.35 <sup>49</sup>	0.0 <sup>47</sup>	na	8.9 <sup>50</sup>	0.33 <sup>50</sup>	1.8 <sup>51</sup>
Late successional	5.7 <sup>54</sup>	0.42 <sup>55</sup>	27 <sup>56</sup>	0.17 <sup>57</sup>	4.0 <sup>58</sup>	0.34 <sup>59</sup>	1.4 <sup>60</sup>
Sahel Bushland							
Grazed, fallow	1.1 <sup>62</sup>	1.1 <sup>63</sup>	1.7 <sup>64</sup>	0.64 <sup>63</sup>	3.0 <sup>63</sup>	1.0 <sup>63</sup>	<0.1 <sup>63</sup>
Subdesert grassland							
Grazed, unused	0.1	1.1	0.2	0.64	0.3	1.0	<0.1
Total							

### Soil nitrogen

The bulk of the nonatmospheric nitrogen in West Africa is in the soil. Approximately  $4\text{--}15 \times 10^{12}$  kg reside in this pool to 150 cm depth (Table 18), although the proportion of this nitrogen that actively cycles in the soil-plant system is not known with certainty. West African soil nitrogen pools vary by soil groups (Fig. 5) from  $<0.1 \times 10^3$  to  $>70 \times 10^3$  kg/ha, though most soils fall in the  $5\text{--}40 \times 10^3$  kg/ha range. Variation within groups can be as great as a factor of 15 or more (FAO-UNESCO 1977, Asamoah 1980), and reflects variation in topographic relief and land use history.

Most soil nitrogen is in organic forms; mineral-N commonly makes up  $<2\%$  of total soil N, although  $\text{NH}_4^+$ -N fixed in clay lattices has been reported to comprise 12–33% of total soil nitrogen to 150 cm in at least four Nigerian profiles (Moore and Ayeke 1965). Kudeyarov (1980) has suggested that this fixed N may be more active than commonly presumed.

It is not possible to estimate regional nitrogen mineralization rates with precision based on these data. Many authors (e.g., Hainnaux et al. 1980, Penning de Vries et al. 1980b, Wetselaar 1980) have pointed out that rates vary widely and independently of total per-

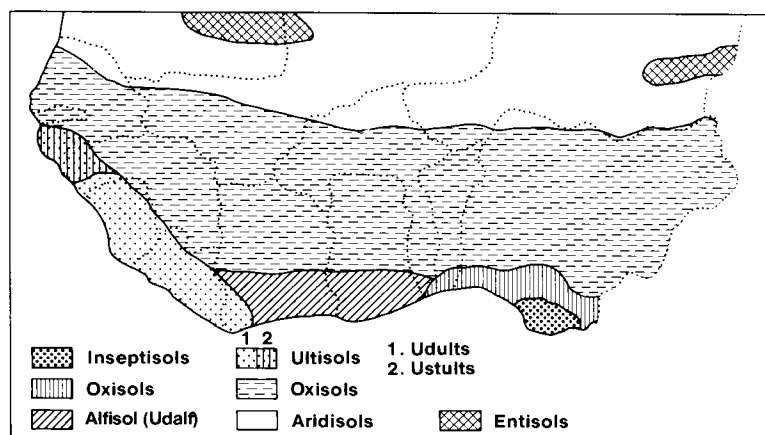

FIG. 5. Major soil groups in West Africa (from Okigbo 1980). See Table 18 for nitrogen contents.



TABLE 12. Continued.

Litter	Standing deadwood		Total N	
	N (%)	Biomass (10 <sup>3</sup> kg/ha)	Local (10 <sup>3</sup> kg/ha)	Re- gional (10 <sup>9</sup> kg)
1.1 <sup>1</sup>	2.5 <sup>1</sup>	0.18 <sup>1</sup>	0.6	15.6
1.4 <sup>2</sup>	17 <sup>2</sup>	0.21 <sup>2</sup>	0.7	2.3
1.3	70 <sup>8</sup>	0.2 <sup>2</sup>	3.1	2.5
1.4 <sup>17</sup>	0.9 <sup>18</sup>	0.3 <sup>19</sup>	0.5	14.4
1.3 <sup>19</sup>	92 <sup>20</sup>	0.3 <sup>20</sup>	1.0	3.2
1.4 <sup>28</sup>	121 <sup>26</sup>	0.34 <sup>26</sup>	1.5	1.2
0.96 <sup>37</sup>	<0.1 <sup>29</sup>	na	<0.1	0.9
0.88 <sup>46</sup>	<0.1 <sup>47</sup>	na	1.0	8.3
0.25 <sup>52</sup>	<0.1	na	0.7	2.2
0.34 <sup>61</sup>	<0.1	na	4.5	10.5
0.55 <sup>63</sup>	<0.1 <sup>63</sup>	na	0.2	1.9
na	<0.1	na	<0.1	0.5
				63.5

cent nitrogen and that current understanding and methodologies preclude accurate predictions of rates even within given vegetation/precipitation zones. Nevertheless, for most West African systems mineralization rates are likely to be between 2 and 10% of total soil N per year (de Rham 1970, Bernhard-Reversat 1974, 1977b, 1981, 1982, Jones and Wild 1975, Greenland 1980, Singh and Balasubramanian 1980a, Wetselaar 1980); within this range, higher rates are likely to occur in forested sites and in sites recently cleared, lower rates in savannas and grasslands, and low to moderate rates in the Sahel and in systems cropped for >2-3 yr.

THE WEST AFRICAN NITROGEN BALANCE

The overall N balance in West Africa (Fig. 6) portrays a cycle dominated by inputs from both precipitation and N<sub>2</sub> fixation in noncultivated systems; by outputs via fire, hydrologic fluxes, and denitrification; and by internal immobilization of nitrogen in growing vegetation. The degree to which our budget balances (within 1%) is striking, particularly since each of the listed fluxes was calculated independently of the others. Because many of our estimates for these fluxes are

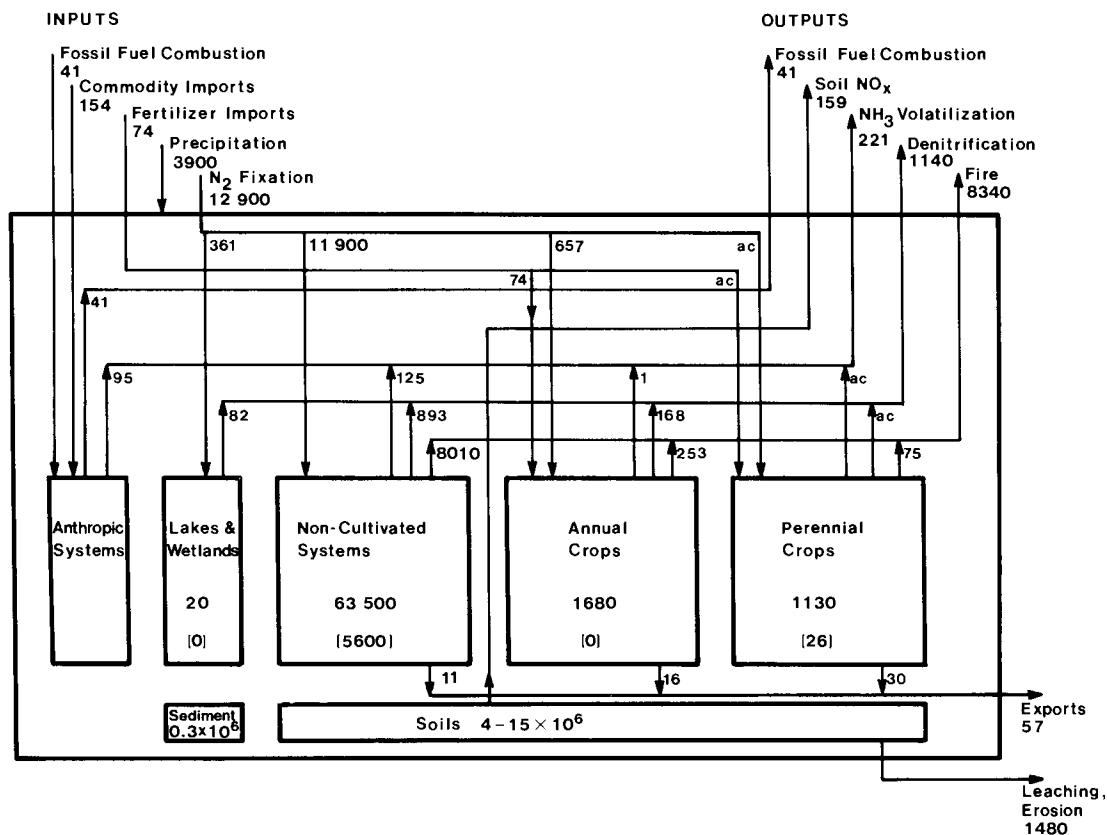

FIG. 6. The overall nitrogen cycle in West Africa in 1978. Flux values are 10<sup>6</sup> kg/yr. Pool values (in boxes) are 10<sup>6</sup> kg. Values in brackets within boxes represent N immobilization (10<sup>6</sup> kg/yr). ac = included in Annual Crop flux.

TABLE 13. Nitrogen turned over and immobilized in vegetation in noncultivated systems.

System	Litterfall (nonwoody)			Litterfall (woody)			Root decomposition	
	Biomass (10 <sup>3</sup> kg/ha)	N content		Biomass (10 <sup>3</sup> kg/ha)	N content		Biomass (10 <sup>3</sup> kg/ha)	N content (%)
		(%)	(kg/ha)		(%)	(kg/ha)		(%)
Lowland rain forest								
Early successional	4.8 <sup>65</sup>	1.6 <sup>65</sup>	77	0.3 <sup>65</sup>	0.7 <sup>65</sup>	2.1	0.9 <sup>65</sup>	0.7 <sup>66</sup>
Mid-successional	5.5 <sup>65</sup>	1.6 <sup>65</sup>	88	0.4 <sup>65</sup>	0.7 <sup>65</sup>	2.8	1.1 <sup>65</sup>	0.5 <sup>66</sup>
Mature	8.5 <sup>68</sup>	1.6 <sup>69</sup>	136	1.7 <sup>70</sup>	0.72 <sup>71</sup>	12	1.9 <sup>66</sup>	0.6 <sup>66</sup>
Moist semideciduous forest								
Early successional	2.3 <sup>65</sup>	2.1 <sup>65</sup>	48	2.7	0.6	16	0.3 <sup>65</sup>	1.1 <sup>66</sup>
Mid-successional	2.5 <sup>65</sup>	2.1 <sup>65</sup>	53	11	0.6	66	0.5 <sup>65</sup>	0.9 <sup>66</sup>
Mature	7.0 <sup>74</sup>	2.1 <sup>74</sup>	147	15 <sup>74</sup>	0.60 <sup>74</sup>	88	0.8 <sup>66</sup>	0.9 <sup>66</sup>
Derived savanna grassland								
Early successional <sup>29</sup>	23	0.49	113	0.3	0.2	0.6	1.3 <sup>65</sup>	0.6
Late successional	14 <sup>75</sup>	0.62 <sup>76</sup>	84	3.3 <sup>76</sup>	0.21 <sup>76</sup>	6.9	14 <sup>77</sup>	0.63 <sup>38</sup>
Guinea savanna woodland								
Early successional <sup>47</sup>	7.7	0.44	34	<0.1	0.2	<0.1	4.3 <sup>78</sup>	0.3 <sup>78</sup>
Late successional	4.6 <sup>79</sup>	0.53 <sup>80</sup>	24	2.6 <sup>81</sup>	0.21 <sup>82</sup>	5.5	2.0 <sup>78</sup>	0.3 <sup>78</sup>
Sahel bushland								
Fallow, grazed	1.6 <sup>63</sup>	0.5	8	0.16 <sup>63</sup>	0.64 <sup>63</sup>	1.0	2.3 <sup>63</sup>	1.0 <sup>63</sup>
Subdesert grassland								
Unused, grazed <sup>64</sup>	0.2	0.5	1	<0.1	0.6	0.1	0.2	1.0
Total								

<sup>1</sup> Based on 5-yr-old lowland rain forest (1850 mm annual precipitation) in Zaire (Bartholomew et al. 1953).

<sup>2</sup> Based on 18-yr-old lowland rain forest as in note 1.

<sup>3</sup> Based on lowland rain forests in Ivory Coast: Banco Plateau (2100 mm precipitation), Banco Valley (2100 mm), and Yapo (1740 mm) (Bernhard-Reversat 1970, 1972, 1975a, 1977, Bernhard-Reversat et al. 1978). Banco Valley sites are not included in standing biomass estimates.

<sup>4</sup> 8.0–9.0 × 10<sup>3</sup> kg/ha, *n* = 2; plus 1.5 × 10<sup>3</sup> kg/ha of liana roots. See footnotes 3 and 9.

<sup>5</sup> 425–480 × 10<sup>3</sup> kg/ha, plus 15 × 10<sup>3</sup> kg/ha lianas. See notes 3 and 9.

<sup>6</sup> Estimate based on woody litter % N (see note 71).

<sup>7</sup> Huttel (1975), Bernhard-Reversat et al. (1978; see note 3). Does not include tap roots but does include 7.5 × 10<sup>3</sup> kg/ha lianas (see note 9).

<sup>8</sup> Estimate based on percent of wood dead (13%) in mid-successional forest.

<sup>9</sup> Includes vine biomass based on 24 × 10<sup>3</sup> kg/ha total vine biomass (from note 3 but not Banco Valley site) and 1:10:5 estimated leaf: wood: roots biomass ratio.

<sup>10</sup> Based on (a) 6-yr-old forest in southern Nigeria (1830 mm annual precipitation; Nye and Hutton 1957) and (b) 6-yr-old forest in western Nigeria (1300 mm; Jaiyebo and Moore 1964).

<sup>11</sup> 5.2–5.3 × 10<sup>3</sup> kg/ha, *n* = 2; see note 10.

<sup>12</sup> 1.2–2.0 % N, *n* = 2; see note 10.

<sup>13</sup> 27–28 × 10<sup>3</sup> kg/ha, *n* = 2; see note 10.

<sup>14</sup> 0.3–0.8% N, *n* = 2; see note 10.

<sup>15</sup> Nye and Hutton (1957).

<sup>16</sup> 6–14 × 10<sup>3</sup> kg/ha, *n* = 2; see note 10.

<sup>17</sup> 1.1–1.8% N, *n* = 2; see note 10.

<sup>18</sup> Estimate based on percent of wood dead (3%) in early 2° lowland rain forest.

<sup>19</sup> Based on 20-yr-old Ghana forest (1520 mm precipitation; Nye 1958).

<sup>20</sup> Estimate based on percent of wood dead in mature forest.

<sup>21</sup> Based on (a) 20+ yr old successional forest in Ghana (1500 mm precipitation; Nye 1958), and (b) 40–50 yr old forest in Kade, Ghana (1650 mm; Greenland and Kowal 1960).

<sup>22</sup> 6–26 × 10<sup>3</sup> kg/ha, *n* = 2; see note 21.

<sup>23</sup> 1.9–2.7% N, *n* = 2; see note 21.

<sup>24</sup> 112–188 × 10<sup>3</sup> kg/ha, *n* = 2; includes total lianas if given separately; see footnote 21.

<sup>25</sup> 0.3–0.5% N, *n* = 2; see note 21.

<sup>26</sup> Greenland and Kowal (1960).

<sup>27</sup> 2.3–5.6 × 10<sup>3</sup> kg/ha, *n* = 2; see note 21.

<sup>28</sup> 1.3–1.5% N, *n* = 2; see note 21.

<sup>29</sup> Based on 4 derived savannas 1, 2, 3 and 4 yr old in Ghana (890 mm precipitation; Nye 1958).

<sup>30</sup> 3–13 × 10<sup>3</sup> kg/ha, *n* = 4; see note 29.

<sup>31</sup> 0.67–2.3% N, *n* = 4; see note 29.

<sup>32</sup> 0.1–10 × 10<sup>3</sup> kg/ha, *n* = 4; see note 29.

<sup>33</sup> *n* = 1; see note 29.

<sup>34</sup> 1.9–3.9 × 10<sup>3</sup> kg/ha, *n* = 3; see note 29.

<sup>35</sup> 0.58–0.8% N, *n* = 4; see note 29.

<sup>36</sup> <0.1–4.6 × 10<sup>3</sup> kg/ha, *n* = 4; see note 29.

TABLE 13. Continued.

Root decomposition N content (kg/ha)	Throughfall	Biomass accretion	Total N uptake	
	N (kg/ha)	N (kg/ha)	Local (kg/ha)	Re-gional (10 <sup>9</sup> kg)
6.3	30 <sup>67</sup>	114 <sup>1</sup>	229	6.2
5.5	34 <sup>67</sup>	39 <sup>1</sup>	170	0.2
11	52 <sup>3</sup>	<0.1	211	0.2
3.3	4 <sup>67</sup>	70 <sup>72</sup>	141	4.0
4.5	4 <sup>67</sup>	24 <sup>73</sup>	152	0.5
7.2	12 <sup>74</sup>	<0.1	254	0.2
7.8	1	3.8 <sup>72</sup>	126	0.8
87	1	<0.1	179	2.9
13	1	8 <sup>72</sup>	56	1.8
6.0	1	<0.1	37	4.4
24	<0.1	<0.1 <sup>63</sup>	33	1.0
2.0	<0.1	<0.1	3	0.2
				22.5

<sup>37</sup>  $n = 1$ ; see note 29.  
<sup>38</sup> Based on 10-yr-old mature derived savanna in Ghana (890 mm precipitation; Nye 1958) and 5 derived savannas at Lamto, Ivory Coast ( $\approx 1300$  mm; Menaut and Cesar 1979). Biomass values are maximum annual values, and leaf:litter ratio is assumed to be same at time of maximum biomass as at time of  $\approx 60\%$  maximum. Litter includes herbaceous biomass only.  
<sup>39</sup>  $1.5-8.41 \times 10^3$  kg/ha,  $n = 8$ ; from references in note 38 and Isichei and Sanford (1980) for Olokomeji, Nigeria (1230 mm) derived savanna, with assumption that maximum standing biomass is  $\approx 50\%$  of total annual leaf litterfall (Menaut and Cesar 1979; and Oguntala 1980 for Olokomeji, Nigeria).  
<sup>40</sup> 0.6-2.1% N,  $n = 2$ ; Nye (1958; see note 38) and Isichei and Sanford (1980; see note 39).  
<sup>41</sup>  $<0.1-54 \times 10^3$  kg/ha,  $n = 6$ ; see note 38.  
<sup>42</sup> Nye (1958); see note 38.  
<sup>43</sup>  $21-43 \times 10^3$  kg/ha,  $n = 5$ ; Menaut and Cesar (1979; see note 38).  
<sup>44</sup> Nye (1958).  
<sup>45</sup>  $1.2-4.6 \times 10^3$  kg/ha; see note 38.  
<sup>46</sup> Oguntala (1980).  
<sup>47</sup> Based on (a) 1-yr-old unburned fallow savanna at Oyo, Nigeria (1200 mm precipitation; Egunjobi 1974) and (b)  $< 6$  yr old *Imperata* savanna in Ghana (Nye 1958).  
<sup>48</sup>  $4-50 \times 10^3$  kg/ha,  $n = 2$ ; see note 47.  
<sup>49</sup> 0.3-0.4% N,  $n = 2$ ; see note 47.  
<sup>50</sup> Nye (1958); see note 47.  
<sup>51</sup>  $0.6-3.0 \times 10^3$  kg/ha,  $n = 2$ ; see note 47.  
<sup>52</sup> 0.2-0.3% N,  $n = 2$ ; see note 47.  
<sup>53</sup> Based on two Guinea *Andropogon* savannas 6-20 and 20+ yr old in Ghana (1500 mm precipitation; Nye 1958).  
<sup>54</sup>  $2-13 \times 10^3$  kg,  $n = 5$ ; based on references in note 53 and (a) southern Guinea high grass savanna woodland at Old Oyo, Nigeria, (b) northern Guinea lowgrass savanna at Kainji Lake, Nigeria, and (c) northern Guinea *Isobelinia* woodland savanna at Kainji Lake, Nigeria (Isichei and Sanford 1980).  
<sup>55</sup> 0.2-0.6% N,  $n = 5$ ; based on same sites as in note 54.  
<sup>56</sup>  $<0.1-54 \times 10^3$  kg/ha,  $n = 2$ ; see note 53.  
<sup>57</sup> Nye (1958); see note 53.  
<sup>58</sup>  $3.8-4.2 \times 10^3$  kg,  $n = 2$ ; see note 53; does not include woody vegetation.

probably only correct to a factor of two, however, the very small difference between outputs plus immobilization and inputs appears fortuitous, and the overall balance should be interpreted with care.

To a substantial degree, nitrogen fluxes in rangelands, forests, and other noncropped areas dominate the regional budget. For example, N<sub>2</sub> fixation in cultivated areas appears to be only  $\approx 5\%$  of that in noncultivated regions, and over 96% of the nitrogen that is lost via fires in West Africa in 1978 appears to have occurred in noncultivated regions. Nevertheless, a large proportion of these losses is indirectly the result of cultivation: cultural practices drive both the establishment of early successional bush fallows and eventual land clearing; both of these processes lead to conditions highly favorable for specific nitrogen cycle fluxes. Almost half of the nitrogen fixed in noncultivated systems, for example, appears to be fixed in early successional (0-6 yr old) forests (Table 2).

<sup>59</sup> 0.3-0.39% N,  $n = 2$ ; see note 53.  
<sup>60</sup>  $1.2-1.6 \times 10^3$  kg/ha,  $n = 2$ ; see note 53.  
<sup>61</sup> 0.3-0.39% N,  $n = 2$ ; see note 53.  
<sup>62</sup> Includes tree leaves: 89 kg/ha; see note 63.  
<sup>63</sup> Based on grazed Sahel savanna at Fete Ole, Senegal (200-300 mm precipitation; Bille 1977).  
<sup>64</sup> Subdesert fluxes and pools assumed to be 10% of those in Sahel.  
<sup>65</sup> Direct data unavailable; flux assumed to be same proportion of that in mature systems as was biomass in Table 12, and N content same as for mature system.  
<sup>66</sup> No data available; assumes 30-yr root turnover rate for mature forests (Jordan and Escalante 1980) and root litter N content same as for root biomass N (Table 12).  
<sup>67</sup> No data available; estimate assumes proportion of throughfall in nonmature vs. mature is same as for leaf biomass (Table 12).  
<sup>68</sup>  $8-9 \times 10^3$  kg/ha,  $n = 3$ ; includes reproductive-tissue litter; see note 3.  
<sup>69</sup>  $1.3-1.8\%$  N,  $n = 3$ ; includes reproductive-tissue litter; see note 3.  
<sup>70</sup>  $1.1-2.6 \times 10^3$  kg/ha,  $n = 3$ ; see note 3.  
<sup>71</sup> 0.6-0.8% N,  $n = 3$ ; see note 3.  
<sup>72</sup> (Living biomass N minus litterfall, throughfall, and root decomposition N) divided by 4 yr (forests) or 2 yr (savannas).  
<sup>73</sup> Based on amount immobilized in early successional vs. late successional lowland rain forest.  
<sup>74</sup> Based on 40-50 yr old successional forest at Kade, Ghana (1650 mm precipitation; Nye 1961).  
<sup>75</sup>  $7-19 \times 10^3$  kg/ha,  $n = 6$ ; based on Menaut and Cesar (1979) and Isichei and Sanford (1980) as in note 39.  
<sup>76</sup> Isichei and Sanford (1980); see note 39.  
<sup>77</sup>  $10-19 \times 10^3$  kg/ha,  $n = 5$ , for herbs; plus  $0.2 \times 10^3$  kg/ha for woody roots if assume decomposition = production (Menaut and Cesar 1979).  
<sup>78</sup> Direct data unavailable; flux assumed to be same proportion of biomass as in derived savanna, and N content same as in root biomass (Table 12).  
<sup>79</sup>  $4-7 \times 10^3$  kg/ha,  $n = 4$ ; Dommergues (1963) for southern Guinea savanna at Mokwa, Nigeria (1180 mm precipitation) and Isichei and Sanford (1980) as in systems in note 54.  
<sup>80</sup> 0.5-0.6% N,  $n = 3$ ; Isichei and Sanford (1980).  
<sup>81</sup>  $0.7-6.7 \times 10^3$  kg/ha,  $n = 4$ ; see note 79.  
<sup>82</sup> Isichei and Sanford (1980).

TABLE 14. Nitrogen in West African lakes. Local units are mg/L (water column) and mg/ha (sediments to 30 cm). na = not available.

Component	Local N concentration			Regional mass (10 <sup>9</sup> kg)
	Mineral	Organic	Total	
Water column	0.06*	0.04	0.10	0.02†
Sediments	na	na	90‡	318†
Total				318

\* For Lake Volta: Okali and Attionu (1974) report 0.02–0.06 mg/L; Obeng (1975) reports 1.1 mg/L.

† Based on total area (8.0 × 10<sup>6</sup> ha) and volume (0.5 × 10<sup>12</sup> km<sup>3</sup>) of West African lakes (UNESCO 1978; FAO 1979a); seasonal maximum area is assumed for Lake Chad.

‡ To depth of 30 cm assuming sediment density of 2.0 g/cm<sup>3</sup> and 1.5% N (range for temperate lakes: 0.1–4.0% N; Macgregor and Keeney 1975).

In contrast to nitrogen cycles in temperate regions, direct anthropic/industrial sources and sinks of nitrogen in West Africa are minor. Fertilizer nitrogen in West Africa in 1978 (14 × 10<sup>6</sup> kg produced plus 74 × 10<sup>6</sup> kg imported) and nitrogen produced during fossil fuel combustion (41 × 10<sup>6</sup> kg) together were a small fraction of the nitrogen produced biologically ≈ 12 800 × 10<sup>6</sup> kg; this contrasts sharply with estimates for global fluxes that show anthropic sources of fixed nitrogen approaching the importance of biological sources for the planet as a whole (CAST 1976, Söderlund and Svensson 1976). Keeney (1979) estimated that in Wisconsin in 1974, nitrogen fertilizer inputs alone were ≈ 30% of inputs from biological N<sub>2</sub> fixation.

TABLE 15. Annual gaseous nitrogen losses from West Africa via fire (NO<sub>x</sub>-N volatilization), NH<sub>3</sub>-N volatilization, and denitrification (N<sub>2</sub>O-N and N<sub>2</sub>-N emission). \* na = not available.

System	Fire		Denitrification		NH <sub>3</sub> volatilization	
	Local (kg/ha)	Regional (10 <sup>9</sup> kg)	Local (kg/ha)	Regional (10 <sup>9</sup> kg)	Local (kg/ha)	Regional (10 <sup>9</sup> kg)
Lowland rain forest						
Cleared <sup>1</sup>	na	2.8 <sup>2</sup>	20 <sup>3</sup>	0.10	na <sup>3</sup>	<0.01
Successional	<0.1	<0.01	10 <sup>4</sup>	0.3	<0.1 <sup>5</sup>	<0.01
Mature	<0.1	<0.01	20 <sup>4</sup>	<0.01	<0.1 <sup>5</sup>	<0.01
Moist semideciduous forest						
Cleared	na	2.7 <sup>2</sup>	20 <sup>3</sup>	0.10	na <sup>3</sup>	<0.01
Successional	<0.1	<0.01	10 <sup>4</sup>	0.3	<0.1 <sup>5</sup>	<0.01
Mature	<0.1	<0.01	20 <sup>4</sup>	<0.01	<0.1 <sup>5</sup>	<0.01
Derived savanna grassland						
Fallow, grazed	14 <sup>6</sup>	0.3	1 <sup>7</sup>	0.02	<0.1	<0.01
Guinea savanna woodland						
Fallow, grazed	13 <sup>8</sup>	1.9	1 <sup>7</sup>	0.2	0.6	0.07
Sahel bushland						
Grazed, fallow	6 <sup>9</sup>	0.2	1 <sup>10</sup>	0.03	0.6 <sup>11</sup>	0.02
Subdesert grassland						
Grazed, unused	0.6 <sup>12</sup>	<0.1	0.1 <sup>12</sup>	<0.01	0.5 <sup>13</sup>	0.04
Wetlands						
Lakes	<0.1	<0.01	10 <sup>14</sup>	0.08	<0.1 <sup>15</sup>	<0.01
Cultivated systems						
Forests <sup>16</sup>	na	na	5 <sup>17</sup>	0.08	<0.1 <sup>15</sup>	0.01
Savanna	na	na	2 <sup>19</sup>	0.08	<0.1 <sup>18</sup>	0.01
Sahel	na	na	1 <sup>10</sup>	<0.01	<0.1	0.01
Lowland rice	na	na	5 <sup>20</sup>	<0.01	1 <sup>21</sup>	<0.01
Total cultivated		0.3 <sup>22</sup>		0.2		<0.01
Total		8.3		1.1		0.1

\* Gaseous losses from fertilizer and manure are included in Table 16, and losses from other NO<sub>x</sub> sources are included in text. Regional N losses (10<sup>6</sup> kg) are based on system extensions (Fig. 3).

<sup>1</sup> Assumes 5% of all mature forest, 10% of all mid-successional growth, and 17% of all early successional growth was cleared in 1978; thus 5.0 × 10<sup>6</sup> ha of lowland rain forest and 5.2 × 10<sup>6</sup> of semideciduous forest is presumed to have been deforested in 1978.

<sup>2</sup> See Table 12 for N in each system type; assumes that 95% of nonharvested biomass in forests is burned upon clearing (Vitousek et al. 1980); harvested biomass = industrial roundwood production (FAO 1979e), with 60% assumed to have been taken from mature lowland rain forest and 40% from mature semideciduous forest.

<sup>3</sup> Denitrification + leaching N losses = 50 kg·ha<sup>-1</sup>·yr<sup>-1</sup> (Vitousek et al. 1980); estimate assumes that denitrification in cleared forest is 1.4 × denitrification in successional sites since leaching + denitrification in cleared sites is ≈ 1.4 × that in successional sites (Vitousek et al. 1980).

<sup>4</sup> Vitousek et al. (1980): N losses of <20 kg·ha<sup>-1</sup>·yr<sup>-1</sup>; Greenland (1962): "measurable"; mature forest soils assumed to denitrify at rates close to those of cleared forest (Robertson and Tiedje 1984).

TABLE 16. Ammonia volatilized from commercial fertilizer and manure. LM = live mass. na = not applicable.

Source	N production		NH <sub>3</sub> volatilized	
	By local LM (kg·kg <sup>-1</sup> ·yr <sup>-1</sup> )	Regional (10 <sup>6</sup> kg/yr)	Proportion (%)	Total N (10 <sup>6</sup> kg/yr)
Commercial fertilizer <sup>1</sup>				
Urea-N	na	21	30 <sup>2</sup>	6.1
Inorganic N	na	68	10 <sup>3</sup>	6.8
Manure				
Human	0.09 <sup>4</sup>	653	2 <sup>5</sup>	13
Extensive livestock	0.14	1364	10 <sup>6</sup>	(136) <sup>7</sup>
Farmyard animals	0.15 <sup>8</sup>	135	50 <sup>9</sup>	68
Native animals	0.14	10	10 <sup>6</sup>	1.0
Total manure				82
Total				95 <sup>10</sup>

<sup>1</sup> FAO (1979*f*) and assuming urea-N = 23% of all commercial N-fertilizer consumed (IFDC 1977).

<sup>2</sup> M. Ganry (*personal communication*).

<sup>3</sup> Singh and Balasubramanian (1980*a*).

<sup>4</sup> From Table 11.

<sup>5</sup> Söderlund and Svensson (1976); assumes 20% deposited on soil surface (Singh and Balasubramanian 1980*a*).

<sup>6</sup> Healy et al. (1970).

<sup>7</sup> Includes cattle, sheep, goats, camels, and 50% of horses and asses; included in Table 15 as NH<sub>3</sub> volatilized from grazed systems and calculated here as check only (see text; also see footnote 10).

<sup>8</sup> Loehr and Hart (1970).

<sup>9</sup> Eriksson (1959*a*) in Söderlund and Svensson (1976).

<sup>10</sup> Does not include NH<sub>3</sub> volatilized from extensive livestock. See note 7.

## DISCUSSION

There are two major justifications for synthesizing elemental cycles at the regional, subcontinental level: to better estimate terrestrial fluxes to global pools and thereby improve predictions of the effects of anthropic disturbance on climate, radiation balances, and other global processes; and to identify fluxes in particular

systems that play key roles in the nitrogen economies and consequently the productivities of those systems.

Of major concern to atmospheric chemists are the fluxes of trace gases to the atmosphere from terrestrial sources. Such gases, among them methane, carbon monoxide, nitrous oxide (N<sub>2</sub>O), and other nitrogen oxides (NO<sub>x</sub>), influence atmospheric chemistry and earth

←

<sup>5</sup> Main internal transfer except on cleared sites (Vitousek et al. 1980, Denmead et al. 1976); losses from cleared sites included in leaching losses.

<sup>6</sup> N losses of 13–15 kg·ha<sup>-1</sup>·yr<sup>-1</sup>, *n* = 2; Isichei and Sanford (1980); assumes annual burn cycle (Penning de Vries et al. 1980*b*); Vidal and Fauche (1962): 20 kg·ha<sup>-1</sup>·yr<sup>-1</sup>; Nye and Greenland (1960): 28; Singh and Balasubramanian (1980*a*): 25; Penning de Vries et al. (1980*b*): 14.

<sup>7</sup> Wetselaar (1980): N loss of 0 kg·ha<sup>-1</sup>·yr<sup>-1</sup>; Penning de Vries et al. (1980*b*) and Jones and Wild (1975): "low"; Greenland (1962): "low" (young successional vegetation) to "measurable" (late successional).

<sup>8</sup> N losses of 12–14 kg·ha<sup>-1</sup>·yr<sup>-1</sup>, *n* = 3; see footnote 6.

<sup>9</sup> Penning de Vries et al. (1980*b*) = N losses of 3 kg·ha<sup>-1</sup>·yr<sup>-1</sup>; Vidal and Fauche (1962): 10 kg·ha<sup>-1</sup>·yr<sup>-1</sup>; assumes 2-yr burn cycle (Penning de Vries et al. 1980*b*).

<sup>10</sup> Penning de Vries et al. (1980*b*): N losses of 0 kg·ha<sup>-1</sup>·yr<sup>-1</sup>; Hahn and Junge (1977): ≈1 for Cape Verde desert and ≈0.5 for vegetated sand dunes if 5:1 N<sub>2</sub>O:N<sub>2</sub> ratio is assumed; Jones and Wild (1975): "low."

<sup>11</sup> Greenland (1980); Woodmansee et al. (1978) = N losses of 0.5 kg·ha<sup>-1</sup>·yr<sup>-1</sup>; West and Skujins (1977): 1; Penning de Vries et al. (1980*b*): 1+; Wetselaar (1980): 0.0.

<sup>12</sup> Assumed to be 10% of Sahel fluxes.

<sup>13</sup> West and Skujins (1977): N losses of 1 kg·ha<sup>-1</sup>·yr<sup>-1</sup>; Wetselaar (1980): 0 kg·ha<sup>-1</sup>·yr<sup>-1</sup>.

<sup>14</sup> Keeney et al. (1971) and Chen et al. (1972): N losses of 12 kg·ha<sup>-1</sup>·yr<sup>-1</sup> for Wisconsin lake sediment; NAS (1978): 8 kg·ha<sup>-1</sup>·yr<sup>-1</sup> for Florida lake.

<sup>15</sup> Patrick and Mahapatra (1968).

<sup>16</sup> Less the area in rice.

<sup>17</sup> Ayanaba and Veldkamp (1980): N losses of ≈0 kg·ha<sup>-1</sup>·yr<sup>-1</sup>; Hainnaux et al. (1980): <20; Greenland (1962, 1980): "low."

<sup>18</sup> Greenland (1980).

<sup>19</sup> Singh and Balasubramanian (1980*a*): N losses of 0 kg·ha<sup>-1</sup>·yr<sup>-1</sup>; see note 17.

<sup>20</sup> Ayanaba and Veldkamp (1980): N losses of 0 kg·ha<sup>-1</sup>·yr<sup>-1</sup>; Garcia (1974): 0; for fertilized rice, Denmead et al. (1979): 120–240 kg·ha<sup>-1</sup>·yr<sup>-1</sup> if 5:1 N<sub>2</sub>O:N<sub>2</sub> ratio is assumed; Reddy (1982): 100.

<sup>21</sup> Greenland (1980), Reddy (1982).

<sup>22</sup> From Table 7.

TABLE 17. Nitrogen lost in leaching, runoff, and erosion from West Africa, based on Niger River fluxes.

Component	Flux
Niger River watershed	
Annual flow ( $10^9$ m <sup>3</sup> /yr)	218 <sup>1</sup>
NO <sub>3</sub> <sup>-</sup> -N (g/m <sup>3</sup> )	2.4 <sup>2</sup>
NH <sub>3</sub> <sup>+</sup> -N (g/m <sup>3</sup> )	0.014 <sup>3</sup>
Sediment yield ( $10^9$ kg/yr)	35 <sup>4</sup>
Watershed area ( $10^6$ ha)	209 <sup>5</sup>
N discharge (kg/ha)	
NO <sub>3</sub> <sup>-</sup> -N + NH <sub>4</sub> <sup>+</sup> -N	2.5
Organic N	1.7 <sup>6</sup>
Region	
N loss ( $10^9$ kg/yr)	1.5 <sup>7</sup>

<sup>1</sup> Ledger (1969):  $221 \times 10^9$  m<sup>3</sup>/yr; Leopold (1965): 192; Livingston (1963): 292; Martins (1982): 168.

<sup>2</sup> Livingston (1963):  $<0.25-0.5$  g/m<sup>3</sup>; Imevbore (1970): 0.6-8.6; van Bennekom et al. (1978): 0.1.

<sup>3</sup> van Bennekom et al. (1978).

<sup>4</sup> NEDECO (1959):  $21 \times 10^9$  kg/yr; Grove (1972): 38; Sarntheim and Walger (1974): 60; Martins (1982): 19.

<sup>5</sup> Livingston (1963):  $205 \times 10^6$  ha; UNESCO (1978):  $209 \times 10^6$  ha.

<sup>6</sup> Assumes 1% mean N content.

<sup>7</sup> Based on total West Africa area ( $606 \times 10^6$  ha) less sub-desert ( $72.6 \times 10^6$  ha) and desert ( $180 \times 10^6$  ha) areas; see Fig. 3.

radiation balances far out of proportion to their abundance (Crutzen 1983), and concentrations of many appear to be increasing. Nitrous oxide fluxes have received particular attention since the mid-1970's, when it was suspected that agricultural fertilizers might indirectly contribute substantial amounts of N<sub>2</sub>O to the atmosphere (CAST 1976, NAS 1978).

Recent evidence from temperate sites suggests that N<sub>2</sub>O fluxes are also related to the successional status of natural vegetation (Melillo et al. 1983, Robertson and Tiedje 1984), globally a far more important source of N<sub>2</sub>O than agriculture (Duxbury et al. 1982, Banin et al. 1984). If N<sub>2</sub>O fluxes in tropical successions are also high after clearing and in old-growth communities, then tropical deforestation and widespread changes in the lengths of crop fallow periods may also be increasing global fluxes. However, we calculate, based on West African data, that such changes in tropical land use are likely not contributing significantly to increased N<sub>2</sub>O fluxes, and that fluxes may in fact be lower now than in the past. In Table 19 we present relative estimates of denitrification fluxes (N<sub>2</sub> + N<sub>2</sub>O) from rain forest at three successional stages, and extrapolate to regional fluxes now vs. fluxes in the precolonial period based on likely changes in the extents of these successional stages. If certain assumptions underlying these estimates are correct, i.e., if denitrification is highest in cleared and mature forest and if land use distributions are reasonably accurate, and if the proportion of denitrification gas product that is N<sub>2</sub>O does not change systematically in any given succession, then present N<sub>2</sub>O fluxes from West African rain forests may be only 50-75% of precolonial fluxes.

Atmospheric concentrations of N<sub>2</sub>O at present appear to be increasing 0.2-0.4% per year globally (Weiss 1981, Kahlil and Rasmussen 1984). If the calculations above are correct, this increase is perhaps being significantly attenuated by shifts in tropical land use. This attenuation, however, if present, will not likely persist. With mature forests disappearing and with continued

TABLE 18. Soil N pools (to 150 cm depth). Soil classification follows the FAO system; for approximations to FDA system see Asamoia (1980) and Fig. 5. Data from FAO-UNESCO (1977) and Asamoia (1980) unless otherwise noted.

Soil type	Extent ( $10^6$ ha)	N content by depth (%)				Total N*	
		0-20 cm	20-50 cm	50-100 cm	100-150 cm	Local ( $10^3$ kg/ha)*	Regional ( $10^{12}$ kg)
Acrisols	41	0.06-0.69	0.04-0.06	0.04-0.05	0.02-0.04	7.1-28	0.3-1.1
Cambisols	8.7	0.20-0.49	0.02-0.05	0.01-0.03	0.01-0.03	8.4-22	<0.1-0.2
Ferralsols	21	0.1-1.0	0.06-0.29	0.04-0.07	0.02-0.04	10-42	0.2-0.9
Gleysols	10	0.09-0.12	0.03-0.18	0.02-0.14	0.01-0.14	6.5-34	<0.1-0.3
Lithosols	94	0.02†	0.02†	0.02†	0.01†	3.8	0.4
Fluvisols	14	0.05	0.02	0.02†	0.01†	4.7	<0.1
Luvisols	96	0.05-0.76	0.02-0.11	0.02-0.06	0.02-0.05	5.5-36	0.5-3.5
Nitisols	21	0.02-0.49	0.02-0.65	0.01-0.05	0.01-0.03	3.9-49	<0.1-1.0
Arenosols	85	0.04-0.8	0.02-0.8	0.01-0.02	0.01-0.02	4.6-67	0.4-5.7
Regosols	58	0.006	0.005	0.005	0.007	1.4	<0.1
Vertisols	5.6	0.04-0.48	0.02-0.24	0.22	0.12	26-47	0.1-0.3
Planosols	2.1	0.03-0.05	0.02	0.004	0.003	2.3-3.0	<0.1
Xerosols	60	0.07	0.06	0.04	0.02†	9.3	0.6
Yermosols	81	0.32	0.023	0.01†	0.01†	12	1.0
Solonchaks	0.7	0.08	0.07	0.04†	0.02†	8.0-9.0	<0.1
Azonal‡	2.8	0.0001†	0.0001†	0.0001†	0.0001†	0.1	<0.1
Total	602						3.8-15

\* Assumes mean bulk density of 1.6 g/cm<sup>3</sup> for soils >85% sand, 1.5 g/cm<sup>3</sup> for those >50% sand, 1.4 g/cm<sup>3</sup> for >10% sand, and 1.2 g/cm<sup>3</sup> for <10% sand.

† Estimated.

‡ Rock debris and salt flats.

TABLE 19. Estimated denitrification fluxes ( $N_2 + N_2O$ ) from West African rain forests before widespread changes in land use relative to likely present-day fluxes. See also Table 15.

Biome, land use	Local N flux (kg/ha)	Present regional		Earlier regional	
		Extent ( $10^6$ ha)	N flux ( $10^6$ kg/yr)	Extent ( $10^6$ ha)	N flux ( $10^6$ kg/yr)
Lowland rain forest					
Cleared	15-25	5	75-125	1	15-25
Successional	1-10	25	25-250	15	15-150
Mature	15-25	1	15-125	15	225-375
Total			115-400		255-550

population pressures resulting in more frequent clearings of mid-successional forests,  $N_2O$  fluxes from rain forest regions may now be increasing towards pre-colonial levels. Measurements of  $N_2O$  fluxes under successional vegetation in tropical regions would greatly help to clarify these trends.

We were surprised by the overwhelming importance of fire as a vector of nitrogen loss in West Africa; almost 75% of all nitrogen lost is volatilized from burning biomass. Two-thirds of this loss occurs when high-biomass rain forest vegetation is cleared. Because fire is an integral part of the widespread bush fallow cropping system, this rate of loss is not likely to decline significantly in the foreseeable future, and probably will increase, in fact, as population pressures reduce fallow periods. Concomitantly, N immobilization by mid-successional vegetation will decrease.

Fire has important implications at both the regional and local scales. Trace gas release (Crutzen et al. 1979) and carbon aerosol loading of the atmospheric boundary layer (Seiler and Crutzen 1981) may have widespread climatic effects. Locally, the nitrogen ( $\approx 700$  kg/ha) that is available for loss when successional rain forest is burned (Table 12) is a substantial loss relative to crop uptake rates that are probably only 10-20% of this amount per year. Any management practice that could reduce this loss (by inhibiting sprouts and pests by some means other than fire, and thereby allowing slash to remain on site to decompose slowly) could significantly improve the availability of nitrogen to subsequent crops.

Overall, the generality of our West Africa model depends to a large degree on climatic (especially rainfall) fluctuations. Our reservoir and flux values reflect normal precipitation regimes; under other conditions both absolute and relative values will differ. Under drought conditions, for example, inputs from precipitation and  $N_2$  fixation, outputs via denitrification and leaching, and biological immobilization will markedly decline, while nitrogen lost via fire may be substantially elevated. The converse may be true in unusually wet years, although precipitation nitrogen inputs will likely not differ much from normal years. Even in the absence of climatic changes, however, population changes will dramatically affect overall fluxes. As illustrated above for  $N_2O$ , moderate changes in land use can dramati-

cally alter regional balances, and land use is driven by population pressure. In particular, shorter fallow intervals will enhance many of the loss vectors and perhaps lead eventually to a regional balance that shows a net loss of nitrogen. Such an effect may be occurring now if total soil nitrogen is not in the regional steady state assumed in this synthesis. In the absence of detailed soil information, it appears at present that the region is receiving about as much nitrogen as is lost each year.

There is considerable room for improvement for most of the N-cycle estimates presented in our budget. Particularly needed are better estimates of land use categories and direct measures of  $N_2$ ,  $N_2O$ , and  $NO_x$  fluxes in noncropped systems. Also needed are various flux measurements for similar systems at different stages of secondary succession; these measures are especially critical for evaluating the impact of increasing population pressures on atmospheric processes and on nitrogen loading of coastal and pelagic marine systems.

#### ACKNOWLEDGMENTS

We are indebted to the librarians at the Swedish University of Agricultural Sciences library, whose ability to locate sometimes obscure documents made much of this work possible, and to a number of scientists in West Africa and elsewhere who willingly shared unpublished data. We also thank E. Wishinsky for help with compiling several of the tables. D. R. Keeney read and made helpful comments on an early draft. Principal financial support was provided by a SCOPE-Andrew H. Mellon Foundation postdoctoral fellowship to G. Philip Robertson.

#### LITERATURE CITED

- Adams, S. N. 1962. Cacao: soils and manuring. Pages 266-273 in J. B. Wills, editor. Agriculture and land use in Ghana. Oxford University Press, London, England.
- Akehurst, B. C. 1968. Tobacco. Longman, London, England.
- Akinola, J. O., and J. H. Davies. 1978. Effect of sowing dates on forage and seed production of 14 varieties of cowpea (*Vigna unguiculata*). Experimental Agriculture 14:197-203.
- Alimagno, B. V., and T. Yoshida. 1977. *In situ* acetylene-ethylene assay of biological nitrogen fixation in lowland rice soils. Plant and Soil 47:239-244.
- Allos, H. F., and W. V. Bartholomew. 1959. Replacement of symbiotic fixation by available nitrogen. Soil Science 57: 61-66.
- Asamoah, G. K. 1980. A survey of nitrogen levels in the

- major soils of Ghana. Pages 171–180 in T. Rosswall, editor. Nitrogen cycling in West African ecosystems. Royal Swedish Academy of Sciences, Stockholm, Sweden.
- Ayanaba, A., and W. J. Veldkamp. 1980. Denitrification in a toposequence. Pages 311–316 in T. Rosswall, editor. Nitrogen cycling in West African ecosystems. Royal Swedish Academy of Sciences, Stockholm, Sweden.
- Ayers, R. S., and R. L. Branson. 1973. Nitrates in the Upper Santa Ana river basin in relation to groundwater pollution. California Agriculture Experiment Station Bulletin Number 861, University of California, Riverside, California, USA.
- Baillon, A. F., E. Holmes, and A. H. Lewis. 1933. The composition of and nutrient uptake by the banana plant with special reference to the Canaries. Tropical Agriculture 10:139–145.
- Balandreau, J. 1975. Activité nitrogenasique dans la rhizosphère de quelques graminées. Dissertation. Université de Nancy, Paris, France.
- Balandreau, J. P., C. R. Miller, and Y. R. Dommergues. 1974. Diurnal variations of nitrogenase activity in the field. Applied Microbiology 27:662–665.
- Balandreau, J., G. Rinaudo, I. Fares-Hamad, and Y. Dommergues. 1975. Nitrogen fixation in the rhizosphere of plants. Pages 57–70 in W. D. P. Stewart, editor. Nitrogen fixation by free-living micro-organisms. Cambridge University Press, Cambridge, England.
- Balandreau, J. P., G. Rinaudo, M. M. Oumarov, and Y. R. Dommergues. 1976. Pages 611–628 in W. E. Newton and C. J. Nyman, editors. Proceedings of the First International Symposium on Nitrogen Fixation. Volume 2. Washington State University Press, Pullman, Washington, USA.
- Balandreau, J., and G. Villemain. 1973. Fixation biologique de l'azote moléculaire en Savane de Lamto (basse Côte d'Ivoire), résultats préliminaires. Revue d'Ecologie et de Biologie du Sol 10:25–33.
- Balasubramanian, V., and L. A. Nnadi. 1980. Crop residue management and soil productivity in savanna areas of Nigeria. Food and Agriculture Organization Soils Bulletin 43: 106–120.
- Banin, A., J. G. Lawless, and R. C. Whitten. 1984. Global N<sub>2</sub>O cycles—terrestrial emissions, atmospheric accumulation and biospheric effects. Advances in Space Research, Pergamon, New York, New York, USA.
- Bartholomew, W. V., J. Meyer, and H. Laudelout. 1953. Mineral nutrient immobilization under forest and grass fallow in the Yangambi (Belgian Congo) region. Publication de l'Institut Nationale. Etude Agronome Congo Belge (INEAC) Series Scientifique 57:1–27.
- Bascones, L., and J. Lopez Ritas. 1961. La nutrición mineral del ajonjolí. Agronomía Tropical Venezuela 2:17–32 and 93–101.
- Batey, T. 1982. Nitrogen in upland pastures of the U.K. Philosophical Transactions of the Royal Society (London) 296:551–556.
- Beaufils, E. R. 1955. Recherches sur la variation des constituants minéraux dans les feuilles et le latex de l'*Hevea brasiliensis*. Bulletin de la Société de Chimie Biologique 37: 349–360.
- Beirnaert, A. 1941. La technique culturale dans l'Equateur. Influence de la culture sur les réserves en humus et en azote des terres équatoriales. Publication de l'Institut Nationale. Etude Agronome Congo Belge (INEAC) Series Technical 26:1–86.
- Bernhard-Reversat, F. 1970. Etude de la litière et de sa contribution au cycle des éléments minéraux en forêt ombrophile de Côte d'Ivoire. Oecologia Plantarum 5:247–266.
- . 1972. Décomposition de la litière de feuilles en forêt ombrophile de basse Côte d'Ivoire. Oecologia Plantarum 7:279–300.
- . 1974. L'azote du sol et sa participation au cycle biogéochimique en forêt ombrophile de Côte d'Ivoire. Revue d'Ecologie et de Biologie du Sol 11:263–282.
- . 1975a. Recherches sur les cycles biogéochimiques des éléments minéraux majeurs en milieu forestier subéquatorial (Côte d'Ivoire). Thèse Docteur es Sciences Naturelles, d'orsay, Université de Paris-sud, Paris, France.
- . 1975b. Nutrients in throughfall and their quantitative importance in rainforest mineral cycles. Pages 153–159 in F. B. Golley and E. Medino, editors. Tropical ecological systems. Trends in terrestrial and agricultural research. Springer-Verlag, Berlin, Germany.
- . 1977a. Recherches sur les variations stationnelles des cycles biogéochimiques en forêt ombrophile de Côte d'Ivoire. Cahiers ORSTOM (Office de la Recherche Scientifique et Technique Outre-mer) series Pedologie 15:175–189.
- . 1977b. Observations sur la minéralisation *in situ* de l'azote du sol en savane Sahélienne (Sénégal). Cahiers ORSTOM (Office de la Recherche Scientifique et Technique Outre-mer) series Biologie 12:301–306.
- . 1981. Participation of light and organo-mineral fractions of soil organic matter in nitrogen mineralization in a Sahelian savanna soil. Zentralblatt für Bakteriologie, Parasitenkunde, Infektionskrankheiten und Hygiene. 2. Abteil 136:281–290.
- . 1982. Biogéochimical cycle of nitrogen in a semi-arid savanna. Oikos 38:321–332.
- Bernhard-Reversat, F., C. Huttel, and G. Lemee. 1978. Structure and functioning of evergreen rain forest ecosystems of the Ivory Coast. Natural Resources Research UNESCO 14:557–606.
- Bernhard-Reversat, F., and H. Poupon. 1980. Nitrogen cycling in a soil-tree system in a Sahelian savanna. Example of *Acacia senegal*. Pages 363–370 in T. Rosswall, editor. Nitrogen cycling in West African ecosystems. Royal Swedish Academy of Sciences, Stockholm, Sweden.
- Bille, J. C. 1977. Étude de la Production Primaire Nette d'un Ecosystème Sahélien. Travaux et Documents de l'ORSTOM (Office de la Recherche Scientifique et Technique Outre-mer), Number 65. ORSTOM, Paris, France.
- Blondel, D. 1971. Contribution à l'étude de la croissance-matière sèche et de l'alimentation azote des céréales du culture sèche au Sénégal. Agronomie Tropicale (Paris) 26: 707–720.
- Boakye-Boateng, K. B., and D. J. Hume. 1975. The effect of mulching on emergence, growth and seed yield of soybeans (*Glycine max* L. Merr.) in southern Ghana. Ghana Journal of Agricultural Science 8:135–141.
- Bolin, B., E. T. Degens, P. Duvigneaud, and S. Kempe. 1979. The global biogéochimical carbon cycle. Pages 1–53 in B. Bolin, E. T. Degens, S. Kempe, and P. Ketner, editors. The global carbon cycle. Scope 13. John Wiley, Chichester, England.
- Bolin, B., T. Rosswall, J. E. Richey, J. R. Freney, M. V. Ivanov, and H. Rodhe. 1983. C, N, P, and S cycles: major reservoirs and fluxes. Pages 41–66 in B. Bolin and R. B. Cook, editors. The major biogéochimical cycles and their interactions. SCOPE 21. John Wiley, New York, New York, USA.
- Bonnier, C. 1957. Symbiose Rhizobium-legumineuses en région équatoriale. Publication de l'Institut Nationale. Etude Agronome Congo Belge (INEAC) Series Scientifique 72:1–68.
- Boyer, J. 1973. Cycles de la matière organique et des éléments minéraux dans une cacaoyère Camerounaise. Café, Cacao, Thé 17:3–23.
- Braun, H. 1973. Shifting cultivation in Africa (evaluation of questionnaires). Food and Agriculture Organization Soils Bulletin 24:21–36.



- Breman, H., and C. T. de Wit. 1983. Rangeland production and exploitation in the Sahel. *Science* 221:1341-1347.
- Buresh, R. J., M. E. Caselman, and W. H. Patrick. 1980. Nitrogen fixation in flooded soil systems: a review. *Advances in Agronomy* 33:149-192.
- Burns, R. C., and R. W. F. Hardy. 1975. Nitrogen fixation in bacteria and higher plants. Springer-Verlag, Berlin, Germany.
- Cameron, S. H., and O. C. Compton. 1945. Nitrogen in bearing orange trees. *Proceedings of the American Society of Horticultural Science* 46:60-68.
- CAST (Council for Agricultural Science and Technology). 1976. Effect of increased nitrogen fixation on stratospheric ozone. Report Number 53. Iowa State University, Ames, Iowa, USA.
- CEQ (Council on Environmental Quality). 1980. The Global 2000 Report to the President of the U.S.: Entering the Twenty-first Century. Council on Environmental Quality, Washington, D.C., USA.
- Chang, T. T., G. C. Loresto, and O. Tagumpay. 1973. Agronomic and growth characteristics of upland and lowland rice varieties. Pages 645-661 in Rice breeding. International Rice Research Institute (IRRI), Los Banos, Philippines.
- Chen, R. L., D. R. Keeney, J. G. Konrad, A. J. Holding, and D. A. Graetz. 1972. Gas production in sediments of Lake Mendota, Wisconsin. *Journal of Environmental Quality* 1: 155-157.
- Child, R. 1974. Coconuts. Second edition. Longmans Green, London, England.
- Crutzen, P. J. 1983. Atmospheric interactions—homogeneous gas reactions of C, N, and S containing compounds. Pages 67-114 in B. Bolin and R. B. Cook, editors. The major biogeochemical cycles and their interactions. SCOPE 21. John Wiley, New York, New York, USA.
- Crutzen, P. J., L. E. Heidt, P. J. Krasnek, W. H. Pollock, and W. Seiler. 1979. Biomass burning as a source of atmospheric gases CO, H<sub>2</sub>, NO, CH<sub>3</sub>Cl and COS. *Nature* 282: 253-256.
- Dart, P. J., P. A. Huxley, A. R. J. Eaglesham, F. R. Minchin, R. J. Summerfield, and J. M. Day. 1977. Nitrogen nutrition of cowpea. II. Effects of short-term application of inorganic nitrogen on growth and yield of nodulated and non-nodulated plants. *Experimental Agriculture* 13:241-252.
- da Silva, C. S. 1978. Guinea-Bissau. Pages 324-325 in I. W. Buddenhagen and G. J. Persley, editors. Rice in Africa. Academic Press, New York, New York, USA.
- Deat, J., J. Dubernard, A. Joly, and G. Sement. 1976. Exportations minerales du cotonnier et de quelques cultures tropicales en zone de savane Africaine. *Coton et Fibres Tropicales* 31:409-418.
- Deat, M., and G. Sement. 1974. Atelier sur les residues de recolte le cotonnier. Institut des Recherches du Coton et des Textiles Exotiques, Ministère de la Recherche Scientifique, Cote d'Ivoire.
- de Geus, J. G. 1973. Fertilizer guide for the tropics and subtropics. Centre d'Étude de l'Azote, Zurich, Switzerland.
- Denmead, O. T., J. R. Freney, and J. R. Simpson. 1976. A closed ammonia cycle within a plant canopy. *Soil Biology and Biochemistry* 8:161-164.
- Denmead, O. T., J. R. Freney, and J. R. Simpson. 1979. Nitrous oxide emission during denitrification in a flooded field. *Soil Science Society of America Journal* 43:716-719.
- de Mooy, C. J., J. Pesek, and E. Spaldon. 1973. Mineral nutrition. Pages 267-352 in B. E. Caldwell, R. W. Howell, R. W. Judd, and H. W. Johnson, editors. Soybeans: improvement, production, and uses. *Agronomy* 16. American Society of Agronomy, Madison, Wisconsin, USA.
- de Rham, P. 1970. L'azote dans quelques forêts, savanes, et terrains de culture d'Afrique tropicale humide. Veröffentlichungen des Geobotanischen Institutes der Eidgenössische Technische Hochschule, Stiftung Rübel in Zürich, Switzerland, Numero 45. Heft.
- Döbereiner, J., J. M. Day, and P. J. Dart. 1972. Nitrogenase activity in the rhizosphere of sugar cane and some other tropical grasses. *Plant and Soil* 37:191-196.
- Döbereiner, J., J. M. Day, and P. J. Dart. 1973. Fixation of nitrogen in the rhizosphere of *Paspalum notatum* and sugar cane. *Pesquisa Agropecuaria Brasileira, Serie Agronomia* 8:153-157.
- Doku, E. V. 1967. Root crops in Ghana. Pages 39-68 in E. A. Tai, W. B. Charles, E. F. Iton, P. H. Haynes, and K. A. Leslie, editors. First International Symposium of Tropical Root Crops. University of the West Indies, Trinidad.
- Dommergues, Y. 1963. Biogeochemical cycles of mineral elements in tropical formations. *Bois et Forêts des Tropiques* 87:9-25.
- Drysdale, V. M. 1965. The removal of nutrients by the maize crop. *East Africa Agriculture and Forestry Journal* 31:189-190.
- Duxbury, J. M., D. R. Bouldin, R. E. Terry, and R. L. Tate. 1982. Emissions of nitrous oxide from soils. *Nature* 298: 462-464.
- Eaglesham, A. R. J., F. R. Minchin, R. J. Summerfield, P. J. Dart, P. A. Huxley, and J. M. Day. 1977. Nitrogen nutrition of cowpea (*Vigna unguiculata*). II. Distribution of nitrogen within effectively nodulated plants. *Experimental Agriculture* 13:369-380.
- Egunjobi, J. K. 1974. Litterfall and mineralization in a teak (*Tectona grandis*) stand. *Oikos* 25:222-226.
- Elias, L. G. 1979. Chemical composition of coffee-berry byproducts. Pages 11-16 in J. E. Braham and R. Bressani, editors. Coffee pulp. International Development Research Center, Ottawa, Ontario, Canada.
- FAO (Food and Agriculture Organization). 1965. Fertilizers and their uses. FAO, Rome, Italy.
- . 1970. Amino acid content of foods and biological data on protein. FAO Nutritional Studies Number 24. FAO, Rome, Italy.
- . 1971. Production yearbook, 1970. FAO, Rome, Italy.
- . 1975. Production yearbook, 1974. FAO, Rome, Italy.
- . 1979a. FAO production yearbook, 1978. Volume 32. FAO, Rome, Italy.
- . 1979b. FAO trade yearbook, 1978. Volume 32. FAO, Rome, Italy.
- . 1979c. Yearbook of fishery statistics: catches and landings, 1978. Volume 46. FAO, Rome, Italy.
- . 1979d. Yearbook of fishery statistics: fishery commodities, 1978. Volume 47. FAO, Rome, Italy.
- . 1979e. Yearbook of forest products, 1978. FAO, Rome, Italy.
- . 1979f. FAO fertilizer yearbook, 1978. FAO, Rome, Italy.
- . 1979g. Agricultural residues: quantitative survey. Analysis of an FAO identification survey of the utilization of residue of agriculture, forestry, fisheries, and related industries. FAO Agricultural Services Bulletin, Provisional. FAO, Rome, Italy.
- . 1980a. FAO production yearbook, 1979. Volume 33. FAO, Rome, Italy.
- . 1980b. Organic recycling in Africa. FAO Soil Bulletin 43:1-304.
- FAO-UNESCO (Food and Agriculture Organization-United Nations Educational, Scientific and Cultural Organization). 1977. Soil map of the world, 1:5 000 000. Volume 6. Africa. UNESCO, Paris, France.
- FDA (Federal Department of Agriculture). 1977. Proposed

- paper on fertilizer distribution. Nigeria Federal Department of Agriculture, Lagos, Nigeria.
- Fishwick, R. W. 1970. Sahel and Sudan zone of Northern Nigeria, Northern Cameroons, and the Sudan. Pages 59–85 in R. N. Kaul, editor. *Afforestation in arid zones*. D. W. Junk, The Hague, The Netherlands.
- Fogg, G. E. 1982. Nitrogen cycling in sea waters. *Philosophical Transactions of the Royal Society of London, Series B: Biological Sciences* **296**:511–520.
- Fournier, F. 1967. Research on soil erosion and soil conservation in Africa. *African Soils* **12**:53–96.
- Franke, R. W., and B. H. Chasin. 1980. Seeds of famine. Ecological destruction and the development dilemma in the West Africa Sahel. Allenhead, Osmum, Montclair, New Jersey, USA.
- French, M. H. 1943. The composition and nutritive value of Tanganyika feeding stuffs. *East African Agriculture and Forestry Journal* **3**:126–132.
- Ganry, F., G. Guirad, and Y. R. Dommergues. 1978a. Effect of straw incorporation on the yield and nitrogen balance in the sandy soil–pearl millet cropping system of Senegal. *Plant and Soil* **50**:649–664.
- Ganry, F., P. A. Roger, and Y. R. Dommergues. 1978b. A propos de l'enfouissement des pailles dans les sols sableux tropicaux de Sénégal. *Comptes Rendus des Seances de l'Academie d'Agriculture de France* **64**:445–454.
- Garcia, J. L. 1974. Reduction de l'oxyde nitreux dans les sols de rizieres du Senegal: mesure de l'activite denitrifiante. *Soil Biology and Biochemistry* **6**:79–84.
- Georgi, C. D. V. 1931. The removal of plant nutrients in oil palm cultivation. *Malayan Agriculture Journal* **19**:484–489.
- Gigou, J. 1980. Effects of straw application on the fertilizer needs of a sorghum-cotton rotation in North Cameroon. *Food and Agriculture Organization Soils Bulletin* **43**:186–191.
- Gillier, P. 1966. Les exportations en elements mineraux d'une culture d'arachide dans les differentes zones du Senegal. *Oleagineux* **21**:13–15.
- Godin, V. J., and P. C. Sensely. 1971. Oils and oil seeds. *Tropical Products Institute (TPI) Crop and Product Digest Number 1*. TPI, London, England.
- Goldsworthy, P. R. 1970. The growth and yield of tall and short sorghum in Nigeria. *Journal of Agricultural Science (Cambridge)* **75**:109–122.
- Greenland, D. J. 1962. Denitrification in some tropical soils. *Journal of Agricultural Science (Cambridge)* **58**:227–233.
- . 1977. Contribution of microorganisms to the nitrogen status of tropical soils. Pages 13–25 in A. Ayanaba and P. J. Dart, editors. *Biological nitrogen fixation in farming systems of the tropics*. John Wiley, New York, New York, USA.
- . 1980. The nitrogen cycle in West Africa. Agronomic considerations. Pages 73–82 in T. Rosswall, editor. *Nitrogen cycling in West African ecosystems*. Royal Swedish Academy of Sciences, Stockholm, Sweden.
- Greenland, D. J., and J. M. L. Kowal. 1960. Nutrient content of the moist tropical forest of Ghana. *Plant and Soil* **12**:154–174.
- Greenland, D. J., and P. H. Nye. 1959. Increases in the carbon and nitrogen contents of tropical soils under natural fallows. *Journal of Soil Science* **10**:284–299.
- Greenwood, D. J. 1982. Nitrogen supply and crop yield: the global scene. Pages 45–60 in G. P. Robertson, R. Herrera, and T. Rosswall, editors. *Nitrogen cycling in ecosystems of Latin America and the Caribbean*. *Plant and Soil* **67**:45–60.
- Greenwood, D. J., T. J. Cleaver, M. K. Turner, J. Hunt, K. B. Niendorf, and S. M. H. Loquens. 1980. Comparison of the effects of nitrogen fertilization on the yield, nitrogen content and quality of 21 different vegetation and agricultural crops. *Journal of Agricultural Science (Cambridge)* **95**:471–485.
- Grist, D. H. 1975. Rice. Fifth edition. Longman, London, England.
- Grove, A. T. 1972. The dissolved and solid load carried by some West African Rivers: Senegal, Niger, Benue, and Shari. *Journal of Hydrology* **16**:277–300.
- Hahn, J., and C. Junge. 1977. Atmospheric N<sub>2</sub>O: a critical review. *Zeitschrift für Naturforschung* **32a**:190–214.
- Hainnaux, H. (rapporteur) and others. 1980. Report of the workgroup on agroecosystems in the wet humid tropics. Pages 415–420 in T. Rosswall, editor. *Nitrogen cycling in West African ecosystems*. Royal Swedish Academy of Sciences, Stockholm, Sweden.
- Hance, W. A. 1975. The geography of modern Africa. Second edition. Columbia University Press, New York, New York, USA.
- Hanway, J. J., and C. R. Weber. 1971. Nitrogen, phosphorus, and potassium percentages in soybean (*Glycine max* (L.) Merrill) plant parts. *Agronomy Journal* **63**:286–290.
- Hashimoto, K. 1971. The significance of combined and symbiotically fixed nitrogen for soybean at successive growth stages. *Research Bulletin of the Hokkaido National Agriculture Experiment Station, Sapporo, Japan* **99**:17–29.
- Hauck, R. D., and K. K. Tanji. 1982. Nitrogen transfers and mass balances. Pages 891–925 in F. J. Stevenson, editor. *Nitrogen in agricultural soils*. American Society of Agronomy, Madison, Wisconsin, USA.
- Healy, T. V., H. A. C. McKay, A. Pilbeam, and D. Scargil. 1970. Ammonia and ammonium sulfate in the troposphere over the United Kingdom. *Journal of Geophysical Research* **75**:2317–2321.
- Horne, A. J., and A. B. Viner. 1971. Nitrogen fixation and its significance in tropical Lake George, Uganda. *Nature* **232**:417–418.
- Howeler, R. 1981. Mineral nutrition and fertilization of cassava. *Centro Internacional de Agricultura Tropical (CIAT), Cali, Colombia*.
- Hume, H. H. 1957. *Citrus fruits*. MacMillan, New York, New York, USA.
- Huttel, C. 1975. Root distribution and biomass in three Ivory Coast rain forest plots. Pages 123–130 in F. B. Golley and E. Medina, editors. *Tropical ecological systems*. Springer-Verlag, New York, New York, USA.
- IBAN (Imperial Bureau of Animal Nutrition). 1936. Composition of some African foods and feeding-stuffs mainly of vegetable origin. *Technical Communication Number 6*, Aberdeen, Scotland.
- IFDC (International Fertilizer Development Center). 1977. West Africa fertilizer study. Volumes 1–7. Regional overview. *IFDC Bulletin T3*, Florence, Alabama, USA.
- Imevbore, A. M. A. 1970. The chemistry of the river Niger in the Kainji Reservoir area. *Archiv für Hydrobiologie* **67**:412–431.
- IRAT (Institut de Recherches Agronomiques Tropicales et des Cultures Vivrieres). 1975. Les recherches en agronomie a l'IRAT de 1969 a 1974. *Agronomie Tropicale* **30**:107–190.
- IRRI (International Rice Research Institute). 1975. Major research in upland rice. IRRI, Los Baños, Philippines.
- Isichei, A. O. 1980. Nitrogen fixation by blue-green algal soil crusts in Nigerian Savanna. Pages 191–198 in T. Rosswall, editor. *Nitrogen cycling in West African ecosystems*. Royal Swedish Academy of Sciences, Stockholm, Sweden.
- Isichei, A. O., and W. W. Sanford. 1980. Nitrogen loss by burning from Nigerian grassland ecosystems. Pages 325–332 in T. Rosswall, editor. *Nitrogen cycling in West African ecosystems*. Royal Swedish Academy of Sciences, Stockholm, Sweden.

- Jacob, A., and H. von Uexküll. 1963. Fertilizer use: nutrition and manuring of tropical crops. Verlagsgesellschaft für Ackerbau GmbH, Hanover, Germany.
- Jaiyebo, E. O. 1961. The influence of five different cover treatments on soil fertility in a tropical rain-forest environment. Dissertation. University of London, London, England.
- Jaiyebo, E. O., and A. W. Moore. 1964. Soil fertility and nutrient storage in different soil-vegetational systems in a tropical rain-forest environment. *Tropical Agriculture (Trinidad)* **41**:129-139.
- Johnson, R. M., and W. D. Raymond. 1954. The African oil palm *Elaeis guineensis*. *Colonial Plant and Animal Production* **4**:14-23.
- Johnson, R. M., and W. D. Raymond. 1965. The chemical composition of some tropical food plants: manioc. *Tropical Science* **7**:109-115.
- Johnson, J. W., L. F. Welch, and L. T. Kurtz. 1975. Environmental implications of nitrogen fixation by soybeans. *Journal of Environmental Quality* **4**:303-306.
- Jones, M. J. 1971. Ammonium and nitrate-N in the rainwater at Samaru, Nigeria. *Tellus* **23**:459-461.
- . 1972. Ammonium and nitrate-N in the rainwater at Samaru, Nigeria. *Samaru Research Bulletin* 159, Zaria, Nigeria.
- . 1974. Effects of previous crop on yield and N response of maize at Samaru, Nigeria. *Experimental Agriculture* **10**:273-279.
- Jones, M. J., and A. R. Bromfield. 1970. Nitrogen in the rainfall at Samaru, Nigeria. *Nature* **227**:86.
- Jones, M. J., and A. Wild. 1975. Soils of the West African savanna. Technical Communication Number 55 of the Commonwealth Bureau of Soils, Harpenden. Commonwealth Agricultural Bureaux, Farnham Royal, England.
- Jordan, C. F., and G. Escalante. 1980. Root productivity in an Amazonian rain forest. *Ecology* **61**:14-18.
- Kahlil, M. A. K., and R. A. Rasmussen. 1984. Carbon monoxide in the earth's atmosphere: increasing record. *Science* **224**:54-56.
- Kang, B. T. 1975. Effects of inoculation and nitrogen fertilizer on soybean in West Nigeria. *Experimental Agriculture* **11**:23-31.
- Kassam, A. H., and K. R. Stockinger. 1973. Growth and nitrogen uptake by sorghum and millet in mixed cropping. *Samaru Agricultural Newsletter* **15**:28-32.
- Kay, D. E. 1973. Root crops. TPI (Tropical Products Institute) Crop and Product Digest. TPI, London, England.
- . 1979. Food legumes. TPI (Tropical Products Institute) Crop and Product Digest Number 3. TPI, London, England.
- Keay, R. W. J. 1953. An outline of Nigerian vegetation. Second edition. Government Printer, Lagos, Nigeria.
- Keeney, D. R. 1979. A mass balance of nitrogen in Wisconsin. *Wisconsin Academy of Sciences, Arts and Letters* **67**:95-102.
- Keeney, D. R., R. L. Chen, and D. A. Graetz. 1971. Denitrification and nitrate reduction in sediments: importance to the nitrogen budget of lakes. *Nature* **233**:66-67.
- Kim, C. M. 1973. Influence of vegetation types on intensity of ammonia and nitrous oxide loss from soil. *Soil Biology and Biochemistry* **5**:163-166.
- Knowles, R. 1978. Free-living bacteria. Pages 25-40 in J. Döbereiner, R. H. Burris, A. Hollaender, A. A. Franco, G. A. Neyra, and D. B. Scott, editors. Limitations and potentials for biological nitrogen fixation in the tropics. Plenum, New York, New York, USA.
- Kowal, J. M., and A. H. Kassam. 1978. Agricultural ecology of savanna. A study of West Africa. Clarendon, Oxford, England.
- Koyama, T., and A. App. 1979. Nitrogen balance in flooded rice soils. Pages 95-104 in *Nitrogen and rice*. International Rice Research Institute, Los Baños, Philippines.
- Kudeyarov, V. N. 1980. The nitrogen cycle: pedological considerations. Pages 83-94 in T. Rosswall, editor. *Nitrogen cycling in West African ecosystems*. Royal Swedish Academy of Sciences, Stockholm, Sweden.
- Lal, R. 1977. The soil and water conservation problem in Africa: ecological differences and management problems. Pages 143-149 in D. J. Greenland and R. Lal, editors. *Soil conservation and management in the humid tropics*. Wiley, New York, New York, USA.
- Lean, D. R. S., C. F.-H. Liao, T. P. Murphy, and D. S. Painter. 1978. The importance of nitrogen fixation in lakes. *Ecological Bulletins-NFR* **26**:41-51.
- Ledger, D. C. 1969. The dry season flow characteristics of West African rivers. Pages 83-102 in M. F. Thomas and G. W. Whittington, editors. *Environment and land use in Africa*. Methuen, London, England.
- Leopold, L. B. 1965. Rivers. *American Scientist* **50**:511-537.
- Likens, G. E., F. H. Bormann, R. S. Pierce, J. S. Eaton, and N. M. Johnson. 1977. *Biogeochemistry of a forested ecosystem*. Springer-Verlag, New York, New York, USA.
- Lipman, J. G., and A. B. Corybeare. 1936. Preliminary note on the inventory and balance sheet of plant nutrients in the United States. New Jersey Agricultural Experiment Station Bulletin **607**.
- Livingston, D. A. 1963. Chemical composition of rivers and lakes. Chapter G. Pages 1-64 in M. Fleischer, editor. *United States Geological Survey Professional Paper* **440-G**.
- Loehr, R. C., and S. A. Hart. 1970. Changing practices in agriculture and their effect on the environment. *Critical Review of Environmental Control* **1**:87-92.
- Lynch, D. L. 1968. Field nitrogen fixed by nodule bacteria and some symbiotic relationships exhibited by two soybean selections. *Transactions of the Illinois State Academy of Science* **61**:212-214.
- MacGregor, A. N., and D. R. Keeney. 1975. Nutrient reaction. Pages 237-257 in N. F. Stanley and M. P. Alpers, editors. *Manmade lakes and human health*. Academic Press, London, England.
- Makarov, B. N. 1969. Liberation of nitrogen dioxide from soil. *Pochvodenie* 1969:49-53 (English summary).
- Martin-Prevel, P., J. J. Lacoecilhe, and J. Marchal. 1968. Les elements minéraux dans le bananier "Gros Michel" du Cameroun. *Fruits* **23**:259-269.
- Martins, O. 1982. Geochemistry of the Niger River. Pages 397-418 in E. T. Degens, editor. *Transport of carbon and minerals in major world rivers. Part 1. Mitteilungen aus dem Geologisch-Palaontologischen Institut der Universität Hamburg. Heft 52*. Hamburg, Federal Republic of Germany.
- McTainsh. 1980. Harmattan dust deposition in northern Nigeria. *Nature* **286**:587-588.
- Melillo, J. M., J. D. Aber, P. A. Steudler, and J. P. Schimel. 1983. Denitrification potentials in a successional sequence of northern hardwood forest stands. In R. Hallberg, editor. *Environmental biogeochemistry*. *Ecological Bulletins-NFR* **35**:217-228.
- Menaut, J. C., and J. Cesar. 1979. Structure and primary productivity of Lamto savannas, Ivory coast. *Ecology* **60**:1197-1210.
- Messer, J., and P. L. Brezonik. 1983. Agricultural N model: a tool for regional environmental management. *Environmental Management* **7**:177-187.
- Meyer, J., and E. Pampfer. 1959. Nitrogen content of rain water collected in the humid central Congo Basin. *Nature* **184**:717-718.
- Miller, R. J., and R. B. Smith. 1976. Nitrogen balance in

- the southern San Joaquin Valley. *Journal of Environmental Quality* 5:274-278.
- Mokwunye, U. 1980. Interaction between farmyard manure and NPK fertilizer in savanna soils. *Food and Agriculture Organization Soils Bulletin* 43:192-200.
- Moore, A. W. 1966. Nonsymbiotic nitrogen fixation in soil-plant systems. *Soil Fertility* 29:113-128.
- Moore, A. W., and C. A. Ayeke. 1965. HF-extractable ammonium-N in four Nigerian soils. *Soil Science* 99:335-338.
- Morrison, E. B. 1954. *Feeds and feeding*. Morrison, Ithaca, New York, USA.
- Myers, N. 1980. Conversion of tropical moist forests. National Research Council, Washington, D.C., USA.
- NAS (National Academy of Sciences). 1974. African agricultural research capabilities. National Research Council, Washington, D.C., USA.
- NAS (National Academy of Sciences). 1978. Nitrates: an environmental assessment. National Research Council, Washington, D.C., USA.
- NEDECO. 1959. River studies and recommendations on improvement of Rivers Niger and Benue. North Holland, Amsterdam, The Netherlands.
- Nnadi, L. A., and V. Balasubramanian. 1978a. The role of crop residues in soil conservation and soil fertility of cultivated savanna soils. Samaru Conference Paper 20, Institute for Agricultural Research, Samaru, Nigeria.
- Nnadi, L. A., and V. Balasubramanian. 1978b. Root nitrogen content and transformation in selected grain legumes. *Tropical Agriculture (Trinidad)* 55:23-32.
- Nnadi, L. A., V. Balasubramanian, and L. Singh. 1976. Yield and mineral composition of grain legumes. *Ghana Journal of Agriculture* 9:211-215.
- Norris, D. O. 1969. Observations on the nodulation status of rainforest leguminous species in Amazonia and Guyana. *Tropical Agriculture (Trinidad)* 46:145-151.
- Nye, P. H. 1958. The mineral composition of some shrubs and trees in Ghana. *Journal of the West Africa Science Association* 4:91-98.
- . 1961. Organic matter and nutrient cycles under moist tropical forest. *Plant and Soil* 13:333-346.
- Nye, P. H., and D. J. Greenland. 1960. The soil under shifting cultivation. Technical Communication Number 51 of the Commonwealth Bureau of Soils, Harpenden. Commonwealth Agricultural Bureaux, Farnham Royal, England.
- Nye, P. H., and R. G. Hutton. 1957. Some preliminary analyses of fallows and cover crops at the West African Institute for Oil Palm Research, Benin. *Journal of the West African Institute for Oil Palm Research* 2:237-243.
- Obeng, L. E. 1975. Health problems of the Volta Lake ecosystem. Pages 221-230 in N. F. Stanley and M. P. A. Alpers, editors. *Manmade lakes and human health*. Academic Press, London, England.
- Odu, C. T. I. 1977. Contribution of free-living bacteria to the nitrogen status of humid tropical soils. Pages 257-272 in A. Ayanaba and P. J. Dart, editors. *Nitrogen fixation in farming systems of the tropics*. John Wiley, New York, New York, USA.
- Odu, C. T. I., and H. Vine. 1968. Nonsymbiotic nitrogen fixation in a savanna soil of low organic matter. Pages 335-350 in *Isotopes and radiation in soil organic matter studies*. International Atomic Energy Agency, Vienna, Austria.
- Ofori, C. S. 1972. The effect of nitrogen source on the yield of three sorghum varieties in northern Ghana. *Soils Africa* 17:109-115.
- . 1980. The use of organic materials in increasing crop production in Africa. *Food and Agriculture Organization Soils Bulletin* 43:121-128.
- Oguntala, B. 1980. The effects of fire on aspects of nitrogen cycling in Olokemeji forest reserve, Nigeria. Pages 317-324 in T. Rosswall, editor. *Nitrogen cycling in West African ecosystems*. Royal Swedish Academy of Sciences, Stockholm, Sweden.
- Ohlrogge, A. J. 1960. Mineral nutrition of soybeans. *Advances in Agronomy* 12:229-268.
- Ohlrogge, A. J., and E. J. Kamprath. 1968. Fertilizer use on soybeans. Pages 273-295 in L. B. Nelson, editor. *Changing patterns in fertilizer use*. Soil Science Society of America, Madison, Wisconsin, U.S.A.
- Okali, D. U. U., and R. H. Attionu. 1974. The quantities of some nutrient elements in *Pistia stratiota* L. from the Volta Lake. *Ghana Journal of Agricultural Science* 7:203-208.
- Okigbo, B. N. 1980. Farming systems of West Africa in relation to nitrogen cycling. Pages 131-156 in T. Rosswall, editor. *Nitrogen cycling in West African ecosystems*. Royal Swedish Academy of Sciences, Stockholm, Sweden.
- Pal, U. R., and M. C. Saxena. 1975. Contribution of symbiosis to the nitrogen needs of soybean (*Glycine max* L. Merr.). *Acta Agronomica Academiae Scientiarum Hungaricae* 24:430-437.
- Patrick, W. H., and J. C. Mahapatra. 1968. Transformation and availability to rice of nitrogen and phosphorus. *Advances in Agronomy* 20:323-359.
- Pena, R. S. de la and D. L. Plucknett. 1972. Effects of nitrogen fertilizer on the growth, composition, and yield of upland and lowland taro (*Colocasia esculenta*). *Experimental Agriculture* 8:187-194.
- Penders, J. M. A. 1941. De mogelijkheid van de meststoffenvoorziening van den Nederlandsch Indischen landbouw uit hier te lande aanwezige bronnen. *Landbouw (Buitenzorg Java)* 17:774-843.
- Penning de Vries, F. W. T., J. M. Krul, and H. van Keulen. 1980a. Productivity of Sahelian rangelands in relation to the availability of nitrogen and phosphorus from the soil. Pages 95-114 in T. Rosswall, editor. *Nitrogen cycling in West African ecosystems*. Royal Swedish Academy of Sciences, Stockholm, Sweden.
- Penning de Vries, F. W. T. (rapporteur) and others. 1980b. Report of the Work Group on the Sahel-Savannah zone. Pages 399-408 in T. Rosswall, editor. *Nitrogen cycling in West African ecosystems*. Royal Swedish Academy of Sciences, Stockholm, Sweden.
- Poulain, J.-F. 1980. Crop residues in traditional cropping systems of West Africa. Effects of the mineral balance and level of organic matter in soils and proposals for their better management. *Food and Agriculture Organization Soils Bulletin* 43:38-71.
- Prentice, A. M. 1972. *Cotton, with special reference to Africa*. Longman, London, England.
- Purseglove, J. W. 1968. *Tropical crops: Dicotyledons*. Longman, London, England.
- . 1975. *Tropical crops: Monocotyledons*. Longman, London, England.
- Rachie, K. O., and L. M. Roberts. 1974. Grain legumes of the lowland tropics. *Advances in Agronomy* 26:1-134.
- Reddy, K. R. 1982. Nitrogen cycling in a flooded soil ecosystem planted to rice (*Oryza sativa* L.). In G. P. Robertson, R. Herrera and T. Rosswall, editors. *Nitrogen cycling in ecosystems of Latin America and the Caribbean*. *Plant and Soil* 67:209-220.
- Rees, A. R., and P. B. H. Tinker. 1963. Dry matter production and nutrient content of plantation oil palms in Nigeria. *Plant and Soil* 19:19-32.
- Reynaud, P. A., and P. A. Roger. 1978. Nitrogen fixing algal biomass in Senegal rice fields. *Ecological Bulletins-NFR* 26: 148-157.
- Reynaud, P. A., and P. A. Roger. 1981. Variations saison-

- nières de la flore algale et de l'activité fixatrice d'azote dans un sol engorgé de bas de dune. *Review d'Ecologie et de Biologie du Sol* **18**:9-27.
- Rinaudo, G., J. Balandreau, and Y. Dommergues. 1971. Algal and bacterial nonsymbiotic nitrogen fixation in paddy soils. *Plant and Soil, Special Volume*: 471-479.
- Rinaudo, G., and Y. Dommergues. 1971. Validité de l'estimation de la fixation biologique de l'azote dans la rhizosphère par la méthode de réduction de l'acétylène. *Annales de l'Institut Pasteur* **121**:93-99.
- Robertson, G. P. 1982. Regional nitrogen budgets: approaches and problems. In G. P. Robertson, R. Herrera, and T. Rosswall, editors. *Nitrogen cycling in ecosystems of Latin America and the Caribbean*. *Plant and Soil* **67**:73-80.
- Robertson, G. P., and J. M. Tiedje. 1984. Denitrification and nitrous oxide production in old growth and successional Michigan forests. *Soil Science Society of America Journal* **48**:383-389.
- Rönnner, U. 1985. Nitrogen transformations in the Baltic proper: denitrification counteracts eutrophication. *Ambio* **14**:134-138.
- Roose, E. J. 1974. Influence du type de plante et du niveau de fertilisation sur la composition des eaux de drainage en climat tropical humide. *Communication XIII, Journées de l'Hydraulique Paris, Rapport* **13**.
- . 1978. Pedogenèse actuelle d'un sol ferrugineux complexe issu de granite sous une savane arborescente du centre Haute-Volta Gonsé: campagnes 1968 à 1974. *Cahiers ORSTOM (Office de la Recherche Scientifique et Technique Outre-mer), série Pedologie* **16**:193-223.
- . 1980. Dynamique actuelle de sols ferrallitiques et ferrugineux tropicaux d'Afrique occidentale. *These, Docteur en Sciences, A l'Université d'Orléans, Paris, France*.
- Roskoski, J. P. 1982. Nitrogen fixation in a Mexican coffee plantation. In G. P. Robertson, R. Herrera, and T. Rosswall, editors. *Nitrogen cycling in ecosystems of Latin America and the Caribbean*. *Plant and Soil* **67**:283-291.
- Roskoski, J. P. (rapporteur), E. Bornemisza, J. Aranguren, G. Escalante, and M. B. M. Santana. 1982. Report of the work group on coffee and cacao plantations. In G. P. Robertson, R. Herrera, and T. Rosswall, editors. *Nitrogen cycling in ecosystems of Latin America and the Caribbean*. *Plant and Soil* **67**:403-407.
- Rosswall, T., editor. 1980. *Nitrogen cycling in West African ecosystems*. Royal Swedish Academy of Sciences, Stockholm, Sweden.
- . 1981. The biogeochemical nitrogen cycle. Pages 25-50 in G. E. Likens, editor. *Some perspectives of the major biogeochemical cycles*. SCOPE 17. John Wiley, Chichester, England.
- Rosswall, T., and U. Granhall. 1980. Nitrogen cycling in a subarctic ombrotrophic mire. In M. Sonesson, editor. *Ecology of a subarctic mire*. *Ecological Bulletins-NFR* **30**:209-324.
- Ruschel, A. P., R. L. Victoria, E. Salati, and Y. Henis. 1978. Nitrogen fixation in sugarcane (*Saccharum officinarum* L.). *Ecological Bulletins-NFR* **26**:297-303.
- Ruschel, A. P., and P. B. Vose. 1982. Nitrogen cycling in sugarcane. In G. P. Robertson, R. Herrera, and T. Rosswall, editors. *Nitrogen cycling in ecosystems of Latin America and the Caribbean*. *Plant and Soil* **67**:139-146.
- Ruschel, A. P., P. B. Vose, R. L. Victoria, and E. Salati. 1979. Comparison of isotope techniques and non-nodulating isolines to study the effect of ammonium fertilization on nitrogen fixation in soybean, *Glycine max*. *Plant and Soil* **53**:513-525.
- Salati, E., R. Sylvester-Bradley, and R. L. Victoria. 1982. Regional gains and losses of nitrogen in the Amazon basin. In G. P. Robertson, R. Herrera, and T. Rosswall, editors. *Nitrogen cycling in ecosystems of Latin America and the Caribbean*. *Plant and Soil* **67**:367-376.
- Sanchez, P. A. 1976. *Properties and management of soils in the tropics*. John Wiley and Sons, New York, New York, USA.
- Sarntheim, M., and E. Walger. 1974. Der aolische Sandstrom aus der W-Sahara zur Atlantik-Küste. *Geologische Rundschau* **63**:1065-1073.
- Seiler, W., and P. J. Crutzen. 1981. Estimates of gross and net fluxes of carbon between the biosphere and the atmosphere from biomass burning. *Climatic Change* **2**:207-247.
- Sen, P. K., and A. Lahiri. 1960. Studies on the nutrition of oilseed crops. IV. Effects of phosphorus and sulfur on the uptake of nitrogen and growth and yield of sesame. *Indian Agriculture* **23**:6-10.
- Shorrocks, V. M. 1965a. Mineral nutrition, growth, and nutrient cycle of *Hevea brasiliensis*. I. Growth and nutrient content. *Journal of the Rubber Research Institute of Malaya* **19**:32-47.
- . 1965b. Mineral nutrition, growth, and nutrient cycle of *Hevea brasiliensis*. II. Nutrient cycle and fertilizer requirements. *Journal of the Rubber Research Institute of Malaya* **19**:48-61.
- Singh, A., and V. Balasubramanian. 1980a. Nitrogen cycling in the Savanna zone of Nigeria. Pages 377-392 in T. Rosswall, editor. *Nitrogen cycling in West African ecosystems*. Royal Swedish Academy of Sciences, Stockholm, Sweden.
- Singh, A., and V. Balasubramanian. 1980b. Organic recycling in Asian agriculture. *Food and Agriculture Organization Soils Bulletin* **43**:235-248.
- Smith, P. F., and W. Reuther. 1954. Citrus nutrition. Pages 223-256 in N. F. Childers, editor. *Mineral nutrition of fruit crops*. Horticultural Publications, Rutgers University, New Brunswick, New Jersey, USA.
- Sobulo, R. A. 1972. Studies on white yam (*Dioscorea rotundata*). *Experimental Agriculture* **8**:99-115.
- Söderlund, R., and B. H. Svensson. 1976. The global nitrogen cycle. In B. H. Svensson and R. Söderlund, editors. *Nitrogen, phosphorus, and sulfur-global cycles*. SCOPE 7. *Ecological Bulletins-NFR* **22**:23-73.
- Sollins, P., C. C. Grier, F. M. McCorison, K. Cromack, R. Fogel, and R. L. Fredriksen. 1980. The internal element cycles of an old-growth Douglas-fir ecosystem in Western Oregon. *Ecological Monographs* **50**:261-285.
- Stewart, W. D. P., M. J. Sampaio, A. O. Isichei, and R. Sylvester-Bradley. 1978. Nitrogen fixation by soil algae of temperate and tropical soils. Pages 41-63 in J. Döbereiner, R. H. Burris, A. Hollaender, A. A. Franco, G. A. Neyra, and D. B. Scott, editors. *Limitations and potentials for biological nitrogen fixation in the tropics*. Plenum, New York, New York, USA.
- Steyn, P. L., and C. C. Delwiche. 1970. Nitrogen fixation by nonsymbiotic microorganisms. *Environmental Science and Technology* **4**:1122-1128.
- Thornton, I. 1965. Nutrient content of rainwater in the Gambia. *Nature* **205**:1025.
- Tinker, P. B. H., and K. W. Smilde. 1963. Dry matter production and nutrient content of plantation oil palms in Nigeria. II. Nutrient content. *Plant and Soil* **19**:350-363.
- Tjepkema, J. D., and P. van Berkum. 1977. Acetylene reduction by soil cores of maize and sorghum in Brazil. *Applied and environmental Microbiology* **33**:626-629.
- Traore, T. M., P. A. Roger, P. A. Renaud, and A. Sasson. 1978. Étude de la fixation de N<sub>2</sub> par les cyanobactéries dans une rizière soudano-sahélienne. *Cahiers ORSTOM (Office de la Recherche Scientifique et Technique Outre-mer), Series Biologie* **13**:181-185.
- UN (United Nations). 1977. *World energy supplies, 1971-*

1975. Statistical Papers Series Number 20. United Nations, New York, New York, USA.
- UNESCO (United Nations Educational, Scientific and Cultural Organization). 1978. World water balance and water resources of the earth. Studies and Reports in Hydrology Number 25. UNESCO, Paris, France.
- Urquhart, D. H. 1961. Cocoa. Longmans Green, London, England.
- USDA (United States Department of Agriculture). 1971. Nutritive value of foods. Washington, D.C., USA.
- van Bennekom, A. J., G. W. Berger, W. Helder, and R. T. P. DeVries. 1978. Nutrient distribution in the Zaire estuary and river plume. *Netherlands Journal of Sea Research* 12: 296–323.
- van Rheenen, H. A. 1973. Major problems of growing sesame (*Sesamum indicum* L.) in Nigeria. Communications of the Agricultural University, Mededelingen Landbouwhogeschool, Wageningen, The Netherlands.
- Vest, G., D. F. Weber, and C. Sloger. 1973. Nodulation and nitrogen fixation. Pages 353–390 in B. E. Caldwell, R. W. Howell, R. W. Judd, and H. W. Johnson, editors. Soybeans: improvement, production, and uses. American Society of Agronomy, Madison, Wisconsin, USA.
- Vidal, P., and J. Fauche. 1962. Quelques aspects de la dynamique des elements minéraux d'un sol dior soumis a différentes jacheres. *Agronomie Tropicale (Paris)* 17:828–840.
- Vitousek, P. M. (rapporteur), and others. 1980. Report of the workgroup on tropical forests. Pages 409–414 in T. Rosswall, editor. Nitrogen cycling in West African ecosystems. Royal Swedish Academy of Sciences, Stockholm, Sweden.
- Wallace, A., S. H. Cameron, and R. T. Mueller. 1951. Seasonal use and loss of nutrients and dry matter in orange trees. *Proceedings of the American Society of Horticultural Science* 58:5–10.
- Watanabe, I., and K. K. Lee. 1977. Non-symbiotic nitrogen fixation in rice and rice fields. Pages 289–305 in A. Ayanaba and P. J. Dart, editors. Nitrogen fixation in farming systems of the tropics. Plenum, New York, New York, USA.
- Watanabe, I., K. K. Lee, and M. de Guzman. 1978. Seasonal change of  $N_2$  fixing rate in rice fields assayed by *in situ* acetylene reduction techniques. 2. Estimate of N fixation associated with rice plants. *Soil Science and Plant Nutrition* 24:465–471.
- Weber, C. R. 1966. Nodulating and non-nodulating soybean isolines. II. Response to applied nitrogen and modified soil conditions. *Agronomy Journal* 58:46–49.
- Webster, C. C., and P. N. Wilson. 1980. Agriculture in the tropics. Second edition. Longman, London, England.
- Weiss, E. A. 1971. Castor, sesame and safflower. Leonard Hill, London, England.
- Weiss, R. F. 1981. The temporal and spatial distribution of tropospheric nitrous oxide. *Journal of Geophysical Research* 86:7185–7195.
- West, N. E., and J. Skujins. 1977. The nitrogen cycle in North American cold-winter semi-desert ecosystems. *Oecologia Plantarum* 12:45–53.
- Wetselaar, R. 1980. Nitrogen cycling in a semi-arid region of tropical Australia. Pages 157–170 in T. Rosswall, editor. Nitrogen cycling in West African ecosystems. Royal Swedish Academy of Sciences, Stockholm, Sweden.
- White, F. 1983. UNESCO/AETFAT/UNSO (United Nations Educational Scientific and Cultural Organization/Association pour l'Etude Taxonomique de la Flore l'Afrique Tropicale/United Nations Sudano-Sahelian Office) Vegetation Map of Africa (1:5 000 000). UNESCO, Paris, France.
- Wickens, G. E., and L. P. White. 1979. Land use in the southern margins of the Sahara. Pages 205–242 in B. H. Walker, editor. Management of semi-arid ecosystems. Elsevier, New York, New York, USA.
- Williams, C. N. 1975. The agronomy of the major tropical crops. Oxford University Press, London, England.
- Wills, J. B. 1962. Agriculture and land use in Ghana. Oxford University Press, London, England.
- Woodmansee, R. G., J. L. Dodd, R. A. Bowmann, F. E. Clark, and C. E. Dickinson. 1978. Nitrogen budget of a short-grass prairie ecosystem. *Oecologia (Berlin)* 34:363–376.
- Yoshida, T., and R. R. Ancajas. 1973. Nitrogen fixing activity in upland and flooded rice fields. *Proceedings of the Soil Science Society of America* 37:42–46.
- Yoshida, T., R. A. Rongal, and E. M. Bautista. 1973. Atmospheric nitrogen-fixation by photosynthetic microorganisms in a submerged Philippine soil. *Soil Science and Plant Nutrition* 19:117–123.